

 **Degrenne**
Paris
Créateur d'émotions partagées



Creator of shared emotions



Nous avons un projet commun :

créer des rencontres qui se nourrissent d'une **même passion** :
la Table sous toutes ses formes.

Faire naître une émotion autour de la table nécessite
de réunir différents acteurs où chacun a un rôle unique à jouer.

Du Chef cuisinier aux convives, des Maîtres d'hôtel aux Arts de la table,
nous avons tous à coeur de rendre

ce moment inoubliable dédié à la dégustation.

*We have a shared aim : creating encounters built on a similar passion,
the table in all its forms.*

*Creating an emotion around the table involves bringing together various
protagonists, each of whom has a unique and defining role to play.*

*From the Executive Chef to the Guests, from the Maitre d' to the tableware,
all strive to make this gastronomic moment truly unforgettable.*

Tenemos un proyecto común : crear encuentros que se alimentan
de una misma pasión, la mesa en todas sus formas.

Suscitar una emoción alrededor de la mesa necesita reunir diferentes actores
donde cada uno tiene un papel único que desempeñar.

Del chef cocinero a los comensales, de los maîtres de hotel a las artes de la mesa,
todos desean convertir este momento dedicado
a la degustación en algo inolvidable.

MADE IN FRANCE

Since 1948, Degrenne has worked diligently to highlight the talents of hospitality professionals. Thanks to its authentically French expertise, Degrenne has become the leading European Manufacturer of cutlery and offers today an unprecedented range of tableware to restaurants, hotels and caterers throughout the world.

From flatware to holloware, through tableware and glassware, from the table to the buffet and room service, each design has been created by and for hospitality professionals. Used by world-class Chefs, honored with innovation awards, Degrenne's products set themselves apart by their quality, functionality and elegance thereby to bring that added extra to your tabletop experience. The Degrenne style, timeless and unique, modern, classic or innovative : Make your choice to create your very own Table Art.



Desde 1948, Degrenne realiza su trabajo con fervor para escenificar el talento de los profesionales de la gastronomía.

Gracias a un saber hacer made in France, Degrenne se ha convertido en el primer fabricante de cubiertos de Europa y propone en la actualidad una oferta completa de artes de mesa para los restaurantes, los hoteles y las cafeterías del mundo entero.

Desde los cubiertos a la platería, pasando por la porcelana y la cristalería, de la mesa al buffet pasando por el servicio de habitaciones, cada diseño está pensado por y para los profesionales de la restauración.

Utilizados por grandes chefs en todo el mundo, recompensados por premios de innovación, los productos Degrenne se distinguen por su calidad, su funcionalidad y su elegancia para aportar un extra de alma a sus mesas. El estilo Degrenne, intemporal y único, moderno, clásico o innovador :

Haga su elección para inventar el Arte de su Mesa.

LE SAVOIR FAIRE

Depuis 1948, Degrenne joue sa partition avec ferveur pour mettre en scène le talent des professionnels de la Gastronomie.

Grâce à un **Savoir-Faire Français**, **Degrenne** est devenu le **premier fabricant de couverts européen** et propose aujourd'hui, une offre complète d'Art de la table aux restaurateurs, hôteliers et cafetiers du monde entier.

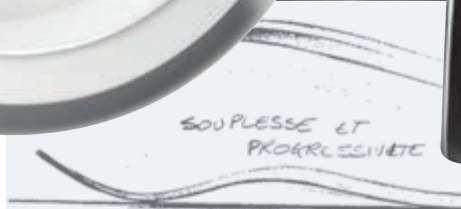
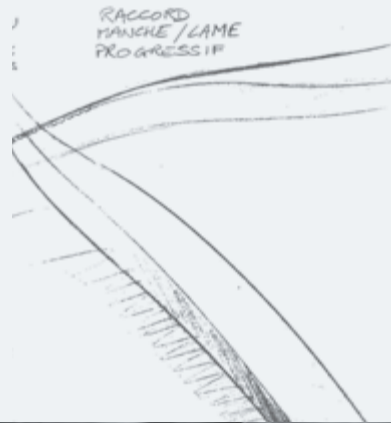

Des couverts à la platerie, en passant par la porcelaine et la verrerie, **chaque design est pensé par et pour les professionnels de la restauration**. Utilisés par des grands Chefs à travers le Monde, récompensés par des prix d'innovation, les produits Degrenne se distinguent par leur qualité et leur élégance pour apporter un supplément d'âme à vos Tables.

Le style Degrenne, intemporel et unique, peut être moderne, classique ou créatif: Faites votre choix pour inventer l'Art de votre Table.

SOMMAIRE-SUMMARY-SOMMARIO

TABLE/TABLEWARE/VAJILLA DE MESA 32-33

Api	40
Boréal	44
Esquisse	42-43
Esquisse graphique	42-43
Gourmet	36-37
Modulo blanc	50-51
Modulo nature	48-49
New moon	41
Newmoon Couture	41
Newcook modulo	50-51
Satin	38-39
SDOne	34-35
Smoos	45
Terra	46-47

THÉ-CAFÉ/TEA-COFFEEWARE/TÉ-CAFÉ 52

Boréal	56
Hulahoop	58
Modulo color	58
Newport	53
Salam	54-55
Satin	56
SDOne	53
Smoos 2.0	57
Smoos 2.0 color	59

COUVERT/FLATWARE/CUBIERTO 62-63

Aloa	112-113
Aquatic	92-93
Astrée ciselé	108-109
Astrée miroir	110-111
Blois	104-105
Confidence	120-121
Guest miroir	106-107
Guest Star	86-87
Isatis	96-97
Lutèce	98-99
Mikado	118-119
Norway	114-115
Ovation	100-101
Petit Gourmet	127
Pièces complémentaires	126
Quartz	124-125
Serenity	82-83
Sillages	116-117
Solstice miroir	102-103
Solstice swing	88-89
Squadro	84-85
Verlaine	94-95
Vieux Paris	122-123
Vintage/Absolu	66-67
Vintage/Contour	70-71
Vintage/Florenzia	68-69
Vintage/Milady	74-75
Vintage/Marquise	72-73
Vintage/Neuilly	76-77
XY Miroir	90-91
XY Black miroir	80-81

SERVICES/SERVICES/SERVICIO 170-175

VERRERIE/GLASSWARE/CRISTALERIA 130-131

Allegro	141
Anytime	136-137
Aromatic	137
Bistrot	134
Boris	136
Brazil	136
Carafes	137
Cosmopolitain	139
Curl	138
Dandy	132
Décanteurs	137
Dolce	140
Domaine	133
Evento	137
Galatée	135
Galatée éclat	135
Loop	136
Mambo	141
Millésime	137
Muse/verres à pied	132
Muse/gobelets	138
Montmartre	134
Nectar	137
New Hypnotic	133
Rondo	136
Vindémia	137

PLATERIE/HOLLOWWARE/ORFÈBRERÍA 44-145

Accessoires platerie	154
Newport cafétérie-pots isothermes	152-153
Newport bar	148-149
Newport plateaux - plats	146-147
Newport accessoires	150-151
Normandie	155
Vertige	155

EVENTO 158-159

evento gourmet	160-161
evento vitaminé	162-165
evento douceur	166-167
evento accessoires	168-169

Nous remercions tous nos clients et partenaires pour leur collaboration dans la réalisation de ce catalogue.

We would to thank all our customers and partners sincerely for their cooperation.

Agradecemos a todos nuestros clientes y colaboradores por su colaboración en la elaboración de este catálogo.

Restaurant L'Office
3 rue Richer, Paris 9ème

Hotel De Nell
7-9 rue du conservatoire, Paris 9ème
www.hoteldenell.com

Café Pinson
6 rue du Forez, Paris 3ème
www.cafepinson.fr

Café-Torréfacteur Coutume Café
47 rue de Babylone, Paris 7ème
www.coutumecafe.com

Restaurant le Café de la Jatte
60 boulevard Vital Bouhot
Neuilly sur seine
www.cafejatte.com

Hôtel Pershing Hall
49 rue Pierre Charron
Paris 8ème
www.pershinghall.com

Restaurant Pierre Sang
55 rue Oberkampf, Paris 11ème
www.pierresangboyer.com

Bar à vin Vingt Heures Vin
17 Rue Joseph de Maistre
Paris 18ème
www.vingtheuresvin.com

Prescription Cocktail Club
23 Rue Mazarine
75006 Paris
www.prescriptioncocktailclub.com

Maison F restaurant & bar
3 Rue Rougemont
75009 Paris
www.maison-f.com



P.6-7 GASTRONOMIE



P.8-9 BISTRONOMIE



P.10-11 CUISINE D'AUTEUR



P.12-13 NÉOBISTROT



P.14-15 CUISINE DE MARCHÉ



P.16-17 BRUNCH



P.18-19 LE CAFÉ DES INITIÉS



P.20-21 TEATIME



P.22-23 OENOLOGIE



P.24-25 BAR & SPIRITUEUX



P.26-27 MIXOLOGIE



P.28-29 SERVICE SUR UN PLATEAU



P.30-31 BUFFET EVENTO

Gastronomie

ESQUISSE

SQUADRO

NEWPORT

DANDY





Bistronomie



BORÉAL

GOURMET

XY BLACK MIROIR

DANDY



Cuisine
d'auteur



API

NEWMOON

XY





Néobistrot

API

MODULO

BLOIS

DOLCE



Taylor's 10ans d'Age 9€
Chateau de la Mission 10 Tradition 45€
Chateau del Vesuvio Capovilla 11€
Dupont Réserve 2010 24€
Cuvée Gordon demi-sec 34€
Remarqué, Foch 34€
Philippine brut 49€
Angela Réserve 69€
Bellocq. Salmon extra brut 69€

Cuisine de marché



TERRA

GOURMET

HYPNOTIC

SOLSTICE



Brunch

SMOOS

MODULO BLANC

ALLEGRO

QUARTZ





Le café des initiés

SMOOS 2.0

GUEST

ALLEGRO

THES DE SPECIALITE		
CHAI LATTE MAISON	4,2	3,8
BREAKFAST BIO	3,5	
THES RISHI BIO	4,5	
GLACE ROOIBOS MYRTILLE		
CAFE COUTUME		
LONDON		
SMOG		
EXTRAS		
SHOT	0,8	
DECAFEINE	0,8	
BABYCINOE	0,8	

VINS COTES DU RHONE	
VERRE	4,5
BOUTEILLE	25
ROUGE	DOMAINE SAINTE ANNE
BLANC	2
ROSE	PAYS D'OC FLEUR DE SEL
	2





Tea time

NEWPORT





L'abus d'alcool est dangereux pour la santé, à consommer avec modération. Alcohol is dangerous for your health, drink with moderation. El abuso del alcohol es peligroso para la salud, consúmase con moderación.

MILLÉSIME

MODULO

API

MUSE

vingt heures vin

A MANGER:

LES SAUPES (OU QUANG NES TERRAINS AVANT):

- JO ATIA : viande, sautes avec le miel, avec des légumes, poulet, jambon et porc, sans viande, 14,8 €
- YIFRE BRUPEL : poulet avec du miel, avec le porc, sans viande, 14,8 €
- EMILE BUISSON : poulet, légumes, avec le porc, sans viande, 14,8 €
- PRINCE LA CANNE : poulet, légumes, avec le porc, sans viande, 14,8 €

ENTRÉES:

- SAUPE & LEGUMES MARINÉS 6,2 €
- OEUF COQUILLE TÔTE GRAS 6,7 €
- OEUF COQUILLE CORNIA 6,7 €
- ASSIETTE DE TÔTE GRAS MAISON YOHÈ AUX 4 EPICES 11,8 €
- PAN CON TOMATE 6,7 €

PLATS:

- CAMEMBERT POTI AU MIEL (COMME DE TERRE RUSTIQUE & SAUPE) 14 €
- TARTINE CHIC 12,8 €
- CARPACCIO DE BRESOLA 15,3 €

DESSERTS MAISON:

- PANNA COTTA 6,2 €
- CREME BRULEE 6,2 €
- FONDANT DOUBLE CHOCOLATS 6,2 €
- OUF 1,2 €
- OUF GOURMAND 1,7 €

LES PLANCHES:

- PETITE CHARCUTERIE 9 €
- GRANDE CHARCUTERIE 17 €
- PETITE FROMAGE 1 €
- PETITE MIXTE 7,3 €
- GRANDE MIXTE 18 €

* POUR VOS APERITIFS *
TOUTES NOS CHARCUTERIES
ET FROMAGES SONT
Aussi VENUS A EMPLOYER !

A BOIRE:

PROFIT DE BOUCHON
VIN : 6 €
CHAMPAGNE : 10 €

JUS DE FRUIT (MAIN MILIAT):

- JUS DE POMME COX'S ORANGE 4,4 €
- JUS D'ORANGE 5,1 €

NECTARS DE FRUIT (MAIN MILIAT):

- NECTAR TOPE D'ÉTÉ 5,1 €
- NECTAR TÊCHE DE VIGNE 5,6 €
- NECTAR DE FRAMBOISE 6 €
- NECTAR DE MANGUE 6,3 €
- NECTAR FRUITS DE LA PASSION 6,6 €

BIÈRE

- (BIO, NON FILTRÉE, NON TROUBLEE)
- BLONDE (MINTZ) 6 € - 50 cl
- BLANCHE (MINTZ) 6 € - 50 cl

Eaux MINÉRALES (HILDON):

- PLATE 75 cl 4,9 €
- GAZÉUSE 75 cl 4,9 €

SODAS:

- LIMONADE D'ANTAN BIO 4,3 €
- COCA BIO REQUIABLE 4,3 €



Bar & Spiritueux

ANYTIME

NEWPORT

BORÉAL

L'abus d'alcool est dangereux pour la santé, à consommer avec modération. Alcohol is dangerous for your health, drink with moderation. El abuso del alcohol es peligroso para la salud, consúmase con moderación.





La mixologie

ANYTIME

NEWPORT

MODULO

L'abus d'alcool est dangereux pour la santé, à consommer avec modération. Alcohol is dangerous for your health, drink with moderation. El abuso del alcohol es peligroso para la salud, consúmase con moderación.



Service sur un plateau

GOURMET

ESQUISSE

DANDY

GUEST STAR

L'abus d'alcool est dangereux pour la santé, à consommer avec modération. Alcohol is dangerous for your health, drink with moderation. El abuso del alcohol es peligroso para la salud, consúmase con moderación.



Buffet evento





TABLEWARE

Tableware is the fruit of a MEETING OF VARIOUS TALENTS.

Like chefs, Degrenne crafts shapes and materials while

paying particular attention to the notions of usage and aesthetics in order

to make time spent at the table a moment dedicated to gastronomic pleasures,

from the most simple to the most elaborate.

The sheer sensory pleasure of drinking tea and coffee is further enhanced by the aesthetic nature of the experience.

Adopting the same approach that has made the brand a leading name in tableware,

Degrenne offers a wide selection of cups, teapots and coffeepots designed to intensify

the taste and enjoyment of connoisseurs, no matter when or where it is served.

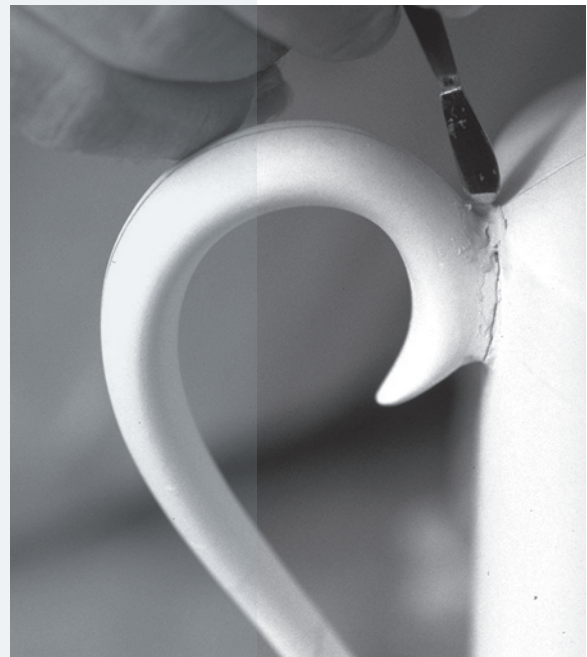
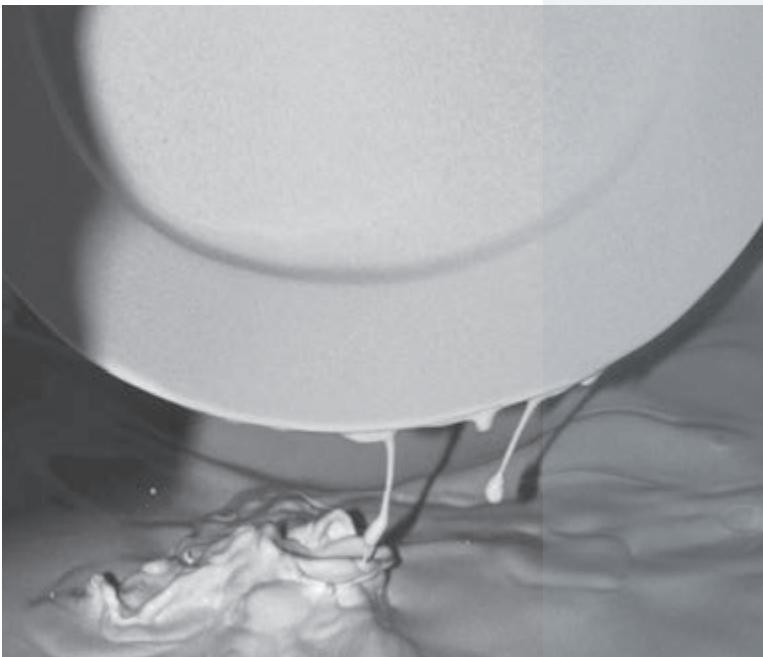

VAJILLA DE MESA

El arte de la mesa es el fruto de una unión de diferentes talentos.

Al igual que los chefs, Degrenne trabaja las formas y las materias prestando una especial atención a las nociones de usos y de estética, para hacer de la mesa un momento dedicado a los placeres gastronómicos, desde el más sencillo al más elaborado.

El té y el café son universos donde el placer de los sentidos se ve aumentado por el placer estético.

Siguiendo la misma línea que supone la fuerza de la marca en las artes de la mesa, Degrenne propone una amplia elección de tazas, teteras y cafeteras que subliman la degustación para un gran placer de los amantes del té y del café independientemente del momento o el lugar donde se sirvan.

LA VAISSELLE

L'Art de la table est le fruit d'une **rencontre entre différents talents.**

Tout comme les Chefs, Degrenne travaille les formes et les matières en portant une attention particulière aux notions d'usages et d'esthétique, pour faire de la table un moment dédié aux plaisirs gastronomiques, du plus simple au plus élaboré.

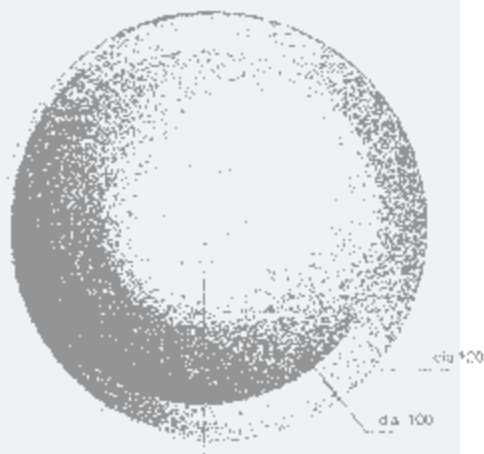

Le thé et le café sont des univers où le plaisir des sens est décuplé par le plaisir esthétique.

En suivant la même démarche qui fait la force de la marque dans les Arts de la table, Degrenne propose un large choix de tasses, théières et verseuses qui subliment la dégustation pour le plus grand bonheur des amateurs quelque soit le moment ou le lieu.

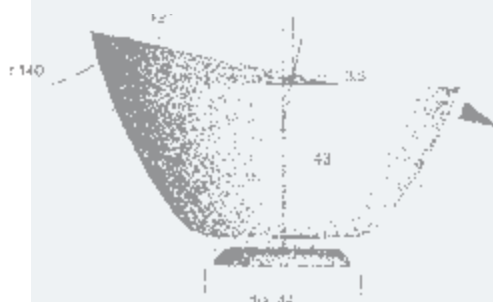

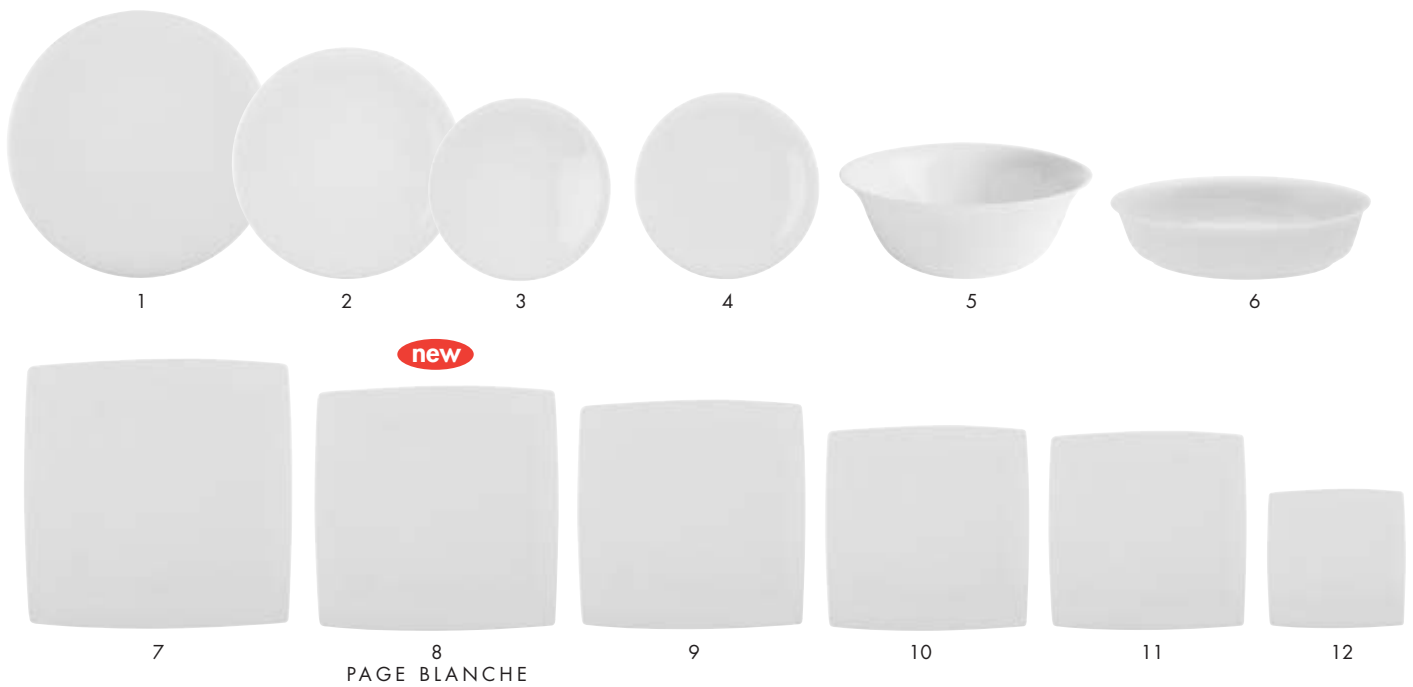

- | | | |
|---|---|--|
| <p>1. 186999 - ASSIETTE DE PRÉSENTATION RONDE
round presentation plate
plato presentación
32 cm - 12,6 inch</p> <p>2. 186994 - ASSIETTE PLATE RONDE
round dinner plate
plato redondo
27 cm - 10,6 inch</p> <p>3. 186996 - ASSIETTE DESSERT RONDE
round dessert plate
plato redondo
21,5 cm - 8,5 inch</p> <p>4. 186998 - ASSIETTE CALOTTE RONDE
cereal bowl/plate
plato hondo
21,5 cm - 8,7 inch</p> <p>5. 187010 - SALADIER
salad bowl deep
ensaladera
26 cm - 10,2 inch</p> | <p>6. 187014 - BAKER
vegetable oval dish
fuente ovalada
29 x 21 cm - 11,4 x 8,3 inch</p> <p>7. 187000 - ASSIETTE DE PRÉSENTATION CARRÉE
flat square presentation plate
plato presentación cuadrado
32 cm - 12,6 inch</p> <p>8. 208889 - PAGE BLANCHE new
square dinner plate
plato cuadrado
27,5 cm - 20,8 inch</p> <p>9. 186995 - ASSIETTE PLATE CARRÉE
square dinner plate
plato cuadrado
25 cm - 9,8 inch</p> <p>10. 186997 - ASSIETTE DESSERT CARRÉE
square dessert plate
plato cuadrado
20 cm - 7,9 inch</p> | <p>11. 187011 - RAVIER CARRÉ
flat square plate
cuenco cuadrado
20 cm - 7,9 inch</p> <p>12. 194417 - ASSIETTE À PAIN CARRÉE
square bread/butter plate
plato de pan cuadrado
16 cm - 6,3 inch</p> <p>13. 187012 - PLAT RECTANGLE CREUX
rectangular deep dish
fuente honda rectangular
43 x 26,5 cm - 16,9 x 10,4 inch</p> <p>14. 187013 - PLAT À CAKE
cake dish, flat
fuente rectangular
41,5 x 16,5 cm - 16,5 x 6,3 inch</p> <p>15. 187009 - COUPELLE
small bowl
bol
14 cm - 5,5 inch</p> |
|---|---|--|

THÉ CAFÉ - TEA COFFEE - TÉ Y CAFÉ **SDONE P.55**



- | | | | |
|---|--|---|--|
| <p>1. 187017 - TASSE CAFÉ
coffee cup
taza de café
9 cl - 3 oz</p> <p>2. 187020 - SOUCOUCPE CAFÉ
moka saucer
plato moka
12,5 cm - 5 inch</p> | <p>3. 187021 - TASSE THÉ
tea cup
taza de té
25 cl - 8^{1/3} oz</p> <p>4. 187022 - SOUCOUCPE THÉ
tea saucer
plato tè
14,5 cm - 5,7 inch</p> | <p>5. 187008 - CRÉMIER
cream jug
lechera
16 cl - 5^{1/3} oz</p> <p>6. 187007 - SUCRIER
sugar bowl
azucarero
45 cl - 15 oz</p> <p>7. 189944 - COUVERCLE SUCRIER
lid for sugar bowl
tapa azucarero</p> | <p>8. 187006 - THÏÈRE
tea pot
tetera
100 cl - 33^{1/3} oz</p> <p>9. 189945 - COUVERCLE THÏÈRE
lid for tea pot
tapa tetera</p> |
|---|--|---|--|

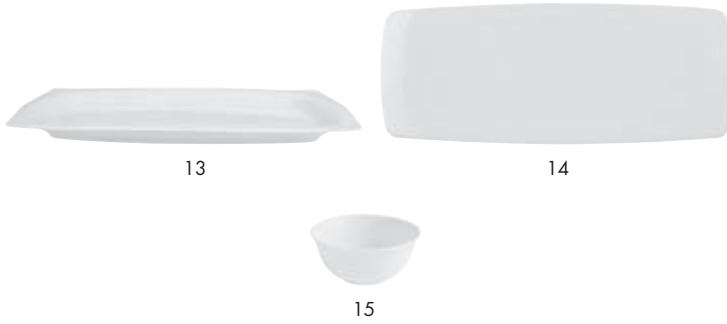

Créée par le Designer Sylvain Dubuisson pour Guy Degrenne
Fabriquée dans nos ateliers de Limoges. Assiette sans aile pour une parfaite association/superposition des formes rondes et carrées.

Created by Sylvain Dubuisson for Guy Degrenne
Manufactured in our workshops based at Limoges.
Plate without shoulder to mix and match round and square shapes perfectly.

©Julie Anstiau **Creada por el diseñador Sylvain Dubuisson para Guy Degrenne**
Fabricada en nuestros talleres de Limoges. Plato sin ala para una perfecta asociación/superposición de las formas redondas y cuadradas.

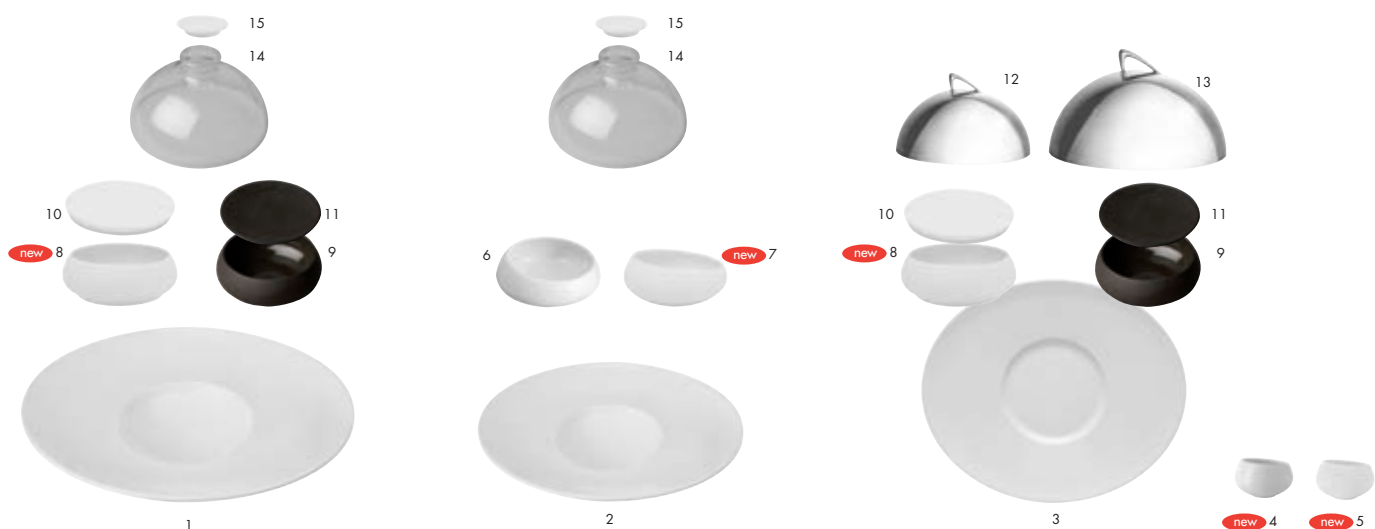

- | | | |
|--|---|---|
| <p>1. 207142 - ASSIETTE GOURMET OVALE
 <i>oval gourmet plate</i>
 <i>plato gourmet</i>
 32x27 cm - 27cl - 12,6x6,7inch - 9 oz</p> | <p>6. 186849 - BOL GOURMET
 <i>gourmet bowl, insert</i>
 <i>bol gourmet</i>
 12 cm - 4,7 inch - 30 cl - 10 oz</p> | <p>11. 204042 - ASSIETTE/COUVERCLE COCOTTE CARBONE
 <i>plate/lid of casserole</i>
 <i>plato/cuerpo cocotte</i>
 12,5 cm - 5 inch</p> |
| <p>2. 207138 - ASSIETTE GOURMET OVALE
 <i>oval gourmet plate</i>
 <i>plato gourmet</i>
 30x26 cm - 17cl - 11,8x10,2 inch - 5²/₃ oz</p> | <p>7. 211893 - BOL GOURMET SABLÉ
 <i>gourmet bowl, insert</i>
 <i>bol gourmet</i>
 12 cm - 4,7 inch - 30 cl - 10 oz</p> | <p>12. 182301 - CLOCHE INOX
 <i>dome cover</i>
 <i>campana</i>
 14,8 cm - 5,8 inch</p> |
| <p>3. 207141 - ASSIETTE GOURMET OVALE BASSIN PLAT
 <i>oval gourmet plate</i>
 <i>plato gourmet</i>
 30x26 cm - 11,8x10,2 inch</p> | <p>8. 209720 - CORPS DE COCOTTE BLANC SABLÉ
 <i>casserole body</i>
 <i>bol</i>
 14 cm - 50 cl - 5,5 inch - 16²/₃ oz</p> | <p>13. 182614 - CLOCHE INOX
 <i>dome cover</i>
 <i>campana</i>
 24 cm - 9,4 inch</p> |
| <p>4. 211891 - MINI BOL GOURMET
 <i>mini gourmet bowl</i>
 <i>mini bol gourmet</i>
 7,3 cm - 2,9 inch - 7 cl - 2¹/₃ oz</p> | <p>9. 204041 - CORPS DE COCOTTE CARBONE
 <i>casserole body</i>
 <i>bol</i>
 14 cm - 50 cl - 5,5 inch - 16²/₃ oz</p> | <p>14. 204043 - CLOCHE VERRE BOROSILICATE
 <i>dome cover</i>
 <i>campana</i>
 17x9 cm - 6,7x3,5 inch</p> |
| <p>5. 211892 - MINI BOL GOURMET SABLÉ
 <i>mini gourmet bowl</i>
 <i>mini bol gourmet</i>
 7,3 cm - 2,9 inch - 7 cl - 2¹/₃ oz</p> | <p>10. 209384 - ASSIETTE/COUVERCLE COCOTTE BLANC
 <i>plate/lid of casserole</i>
 <i>plato/cuerpo cocotte</i>
 12,5 cm - 5 inch</p> | <p>15. 206504 - BOUCHON PORCELAINE POUR CLOCHE VERRE
 <i>porcelain lid for glass dome cover</i>
 <i>tapa de porcelana para campana de vidrio</i>
 5,2 cm - 2 inch</p> |

THÉ CAFÉ - TEA COFFEE - TÉ Y CAFÉ **BORÉAL P.56**



- | | | | |
|--|---|--|---|
| <p>1. 186791 - TASSE CAFÉ
 <i>coffee cup</i>
 <i>taza de café</i>
 9 cl - 3 oz</p> | <p>4. 186794 - SOUCOUPÉ THÉ
 <i>tea saucer</i>
 <i>plato tè</i>
 16,5x14 cm - 6,5x5,5 inch</p> | <p>7. 186775 - MUG
 <i>mug</i>
 <i>mug</i>
 29 cl - 9²/₃ oz</p> | <p>10. 186777 - SUCRIER
 <i>sugar bowl</i>
 <i>azucarero</i>
 14x12 cm - 5,5x4,7 inch</p> |
| <p>2. 186792 - SOUCOUPÉ CAFÉ
 <i>coffee saucer</i>
 <i>plato café</i>
 14x12 cm - 5,5x4,7 inch</p> | <p>5. 186795 - TASSE DÉJEUNER
 <i>breakfast cup</i>
 <i>taza desayuno</i>
 40 cl - 13¹/₃ oz</p> | <p>8. 186776 - VERSEUSE
 <i>coffee pot</i>
 <i>cafetera</i>
 140 cl - 46²/₃ oz</p> | <p>11. 187264 - COUVERCLE SUCRIER
 <i>lid for sugar bowl</i>
 <i>tapa azucarero</i></p> |
| <p>3. 186793 - TASSE THÉ
 <i>tea cup</i>
 <i>taza de té</i>
 20 cl - 6²/₃ oz</p> | <p>6. 186796 - SOUCOUPÉ DÉJEUNER
 <i>breakfast saucer</i>
 <i>plato desayuno</i>
 20x17 cm - 7,9x6,7 inch</p> | <p>9. 189942 - COUVERCLE VERSEUSE
 <i>lid for coffee pot</i>
 <i>tapa cafetera</i></p> | |

GOURMET

ÉVEILLE LES 5 SENS
AWAKENS THE 5 SENSES
DESPIERTA LOS 5 SENTIDOS

La vue, en théâtralisant vos créations culinaires

Sight, by adding a theatrical touch to your culinary creations

La vista, teatralizando sus creaciones culinarias



L'odorat, par la libération progressive des saveurs condensées sous la cloche

Smell, through the progressive release of the fragrances condensed beneath the plate cover

El olfato, mediante la liberación progresiva de los sabores condensados en la campana



Le toucher, par un subtil jeu de matière entre le mat et le brillant

Touch, through a subtle combination of matt and glossy materials

El tacto, mediante un juego sutil de materia entre el mate y el brillo



L'ouïe, grâce au bruit sourd de la cloche qui repose délicatement sur l'assiette

Hearing, thanks to the muted sound of glass plate cover gently resting on the plate

El oído, gracias al ruido sordo de la campana de vidrio soplado que reposa delicadamente sobre el plato



Le goût, au terme d'un parcours gustatif inédit...

Taste, at the conclusion of a unique exploration of flavour...

El gusto, al término de un recorrido gustativo inédito...



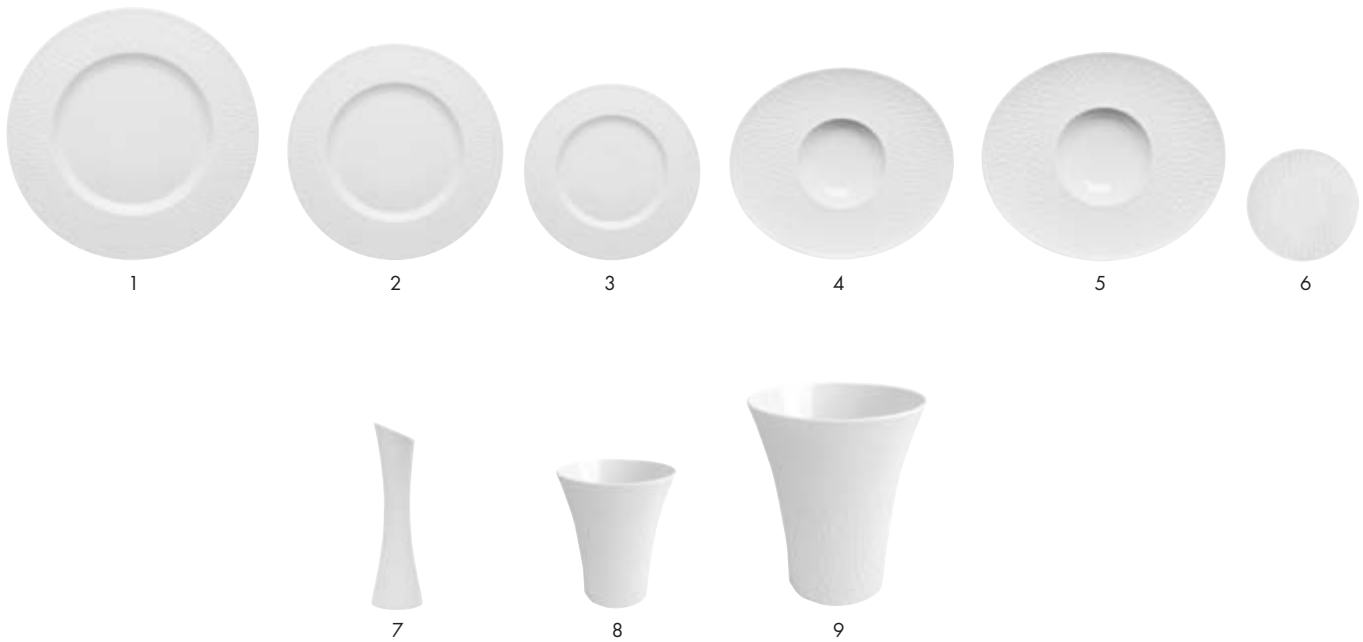

1. 193319 - ASSIETTE DE PRÉSENTATION RONDE

round presentation plate
plato presentación

33 cm - 13 inch

2. 193318 - ASSIETTE PLATE RONDE

round dinner plate
plato redondo

28 cm - 11 inch

3. 193320 - ASSIETTE DESSERT RONDE

round dessert plate
plato redondo

22,5 cm - 8,9 inch

4. 193324 - ASSIETTE GOURMET OVALE

oval gourmet plate
plato oval gourmet

30x26 cm - 17 cl - 11,8x10,2 inch - 5²/₃ oz

5. 207769 - ASSIETTE GOURMET OVALE

oval gourmet plate
plato oval gourmet

32x27 cm - 27 cl - 12,6x10,6 inch - 9 oz

6. 202470 - ASSIETTE À PAIN RONDE

round bread/butter plate
plato pan redondo

15 cm - 5,9 inch

7. 199007 - SOLIFLORE

bud vase
florero

25 cm - 9,8 inch

8. 197427 - VASE

vase
florero decoración

20 cm - 7,9 inch

9. 197427 - VASE

vase
florero decoración

30 cm - 11,8 inch

THÉ CAFÉ - TEA COFFEE - TÉ Y CAFÉ



1. 186791 - TASSE CAFÉ

coffee cup
taza de café

9 cl - 3 oz

2. 193321 - SOUCOUPPE CAFÉ OVALE

oval coffee saucer
plato café

14x12 cm - 5,5x4,7 inch

3. 186793 - TASSE THÉ

tea cup
taza de té

20 cl - 6²/₃ oz

4. 193322 - SOUCOUPPE THÉ OVALE

oval tea saucer
plato tè oval

16,5x14 cm - 6,5x5,5 inch

5. 186795 - TASSE DÉJEUNER

breakfast cup
taza desayuno

40 cl - 13¹/₃ oz

6. 193323 - SOUCOUPPE DÉJEUNER OVALE

oval breakfast saucer
plato desayuno oval

20x17 cm - 7,9x6,7 inch

SATIN



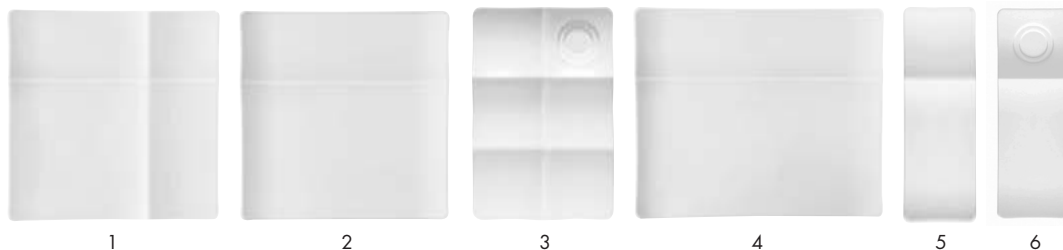

©Julie Ansiau

1. **207129 - ASSIETTE PLATE CARRÉE/4 COMPARTIMENTS**
round presentation plate
plato cuadrado / 4 compartimentos
27 x 27 cm - 10,6 x 10,6 inch
2. **207130 - ASSIETTE PLATE CARRÉE/2 COMPARTIMENTS**
round presentation plate
plato cuadrado / 2 compartimentos
27 x 27 cm - 10,6 x 10,6 inch
3. **207131 - ASSIETTE COMPARTIMENTÉE RECTANGULAIRE**
rectangular plate with compartments
plato rectangular con compartimentos
27 x 18 cm - 10,6 x 7,1 inch
4. **207128 - ASSIETTE PLATE RECTANGULAIRE**
rectangular dinner plate
plato rectangular
27x32 cm - 10,6x12,6 inch
5. **207132 - MODULE RECTANGULAIRE**
rectangular module
modulo rectangular
27x9 cm - 10,6x3,5 inch
6. **207133 - MODULE RECTANGULAIRE/1 EMPREINTE**
rectangular module/1 place
modulo rectangular/ 1 impronta
27x9 cm - 10,6x3,5 inch

THÉ CAFÉ - TEA COFFEE - TÉ Y CAFÉ SALAM P.54-55

new



1 2



3



4 5 6



7

1. **210946 - TASSE CAFÉ**
coffee cup
taza de café
11 cl - 3²/₃ oz
2. **210950 - SOUCOUBE CAFÉ/THÉ**
oval coffee saucer
plato café
16 cm - 6,3 inch
3. **210947 - TASSE THÉ**
tea cup
taza de té
25 cl - 8¹/₃ oz
4. **210948 - TASSE DÉJEUNER**
breakfast cup
taza desayuno
42 cl - 14 oz
5. **210951 - SOUCOUBE DÉJEUNER/MUG**
breakfast/mug saucer
plato/mug desayuno
18 cm - 7,1 inch
6. **210949 - MUG À THÉ**
tea mug
té/mug
38 cl - 12²/₃ oz
7. **211989 - THÉIÈRE 6 TASSES FEUTRE NOIR**
tea pot ó cups
tetera ó tazas
100 cl - 33¹/₃ oz

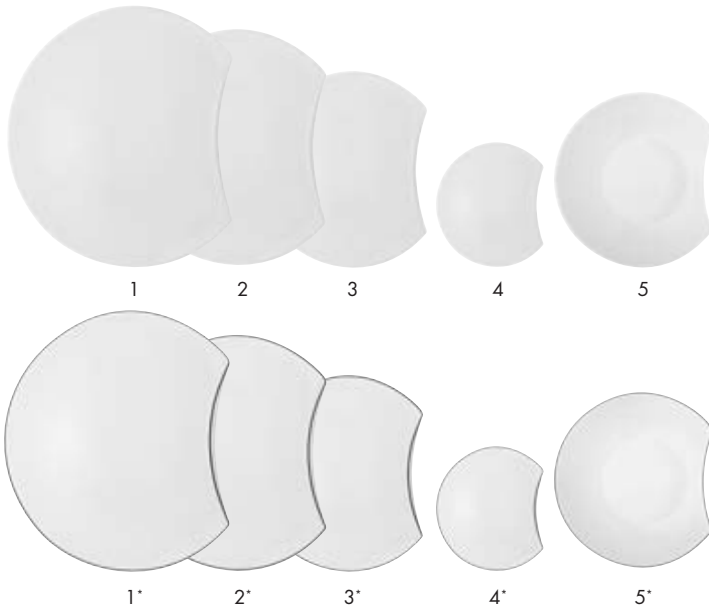

1. **207126 - 204659' ASSIETTE PLATE RONDE**
dinner plate
plato
32 cm - 12,6 inch
2. **207125 - 204458' ASSIETTE PLATE RONDE**
dinner plate
plato
28 cm - 11 inch
3. **207127 - 204457' ASSIETTE PLATE RONDE**
dinner plate
plato
24 cm - 9,4 inch
4. **207124 - 204456' ASSIETTE PLATE RONDE**
dinner plate
plato
16 cm - 6,3 inch
5. **198047 - 206460' SALADIER/BOL**
salad/bowl
bol
20 cm - 7,9 inch



THÉ CAFÉ - TEA COFFEE - TÉ Y CAFÉ SMOOS 2.0 P.57



- | | | |
|---|--|---|
| 1. 207766 - TASSE ESPRESSO
<i>espresso cup</i>
taza de espresso
6 cl - 2 oz | 4. 207767 - TASSE LUNGO
<i>lungo cup</i>
taza de lungo
20 cl - 6 ² / ₃ oz | 7. 161034 - SOUCOUPPE DÉJEUNER
<i>breakfast cup</i>
taza desayuno
21 cm - 8,3 inch |
| 2. 161025 - SOUCOUPPE ESPRESSO/CAFÉ
<i>espresso/coffee saucer</i>
plato espresso café
15 cm - 5,9 inch | 5. 161028 - SOUCOUPPE LUNGO
<i>lungo saucer</i>
plato de lungo
18 cm - 7,1 inch | 8. 207765 - MUG
<i>mug</i>
mug
50 cl - 16 ² / ₃ oz |
| 3. 208948 - TASSE CAFÉ
<i>coffee cup</i>
taza de café
11 cl - 3 ² / ₃ oz | 6. 207768 - TASSE DÉJEUNER
<i>breakfast cup</i>
taza desayuno
48 cl - 16 oz | 9. 209189 - MUG
<i>mug</i>
mug
30 cl - 10,5 oz |

Esquisse



1. **203769 - ASSIETTE PLATE RONDE**
round dinner plate
plato redondo
32 cm - 12,6 inch
2. **203770 - ASSIETTE PLATE RONDE**
round dinner plate
plato redondo
28 cm - 11 inch
3. **203771 - ASSIETTE PLATE RONDE**
round dinner plate
plato redondo
24 cm - 9,4 inch
4. **203772 - ASSIETTE PLATE RONDE**
round dinner plate
plato redondo
14 cm - 5,5 inch

new GRAPHIQUE

P



1. **213936 - ASSIETTE PLATE RONDE**
round dinner plate
plato redondo
32 cm - 12,6 inch
2. **213938 - ASSIETTE PLATE RONDE**
round dinner plate
plato redondo
28 cm - 11 inch
3. **213940 - ASSIETTE PLATE RONDE**
round dinner plate
plato redondo
24 cm - 9,4 inch
4. **213942 - ASSIETTE PLATE RONDE**
round dinner plate
plato redondo
14 cm - 5,5 inch

THÉ CAFÉ - TEA COFFEE - TÉ Y CAFÉ **NEWPORT P.53**



- | | | | |
|---|---|---|---|
| <ol style="list-style-type: none"> 1. 207756 - TASSE ESPRESSO
espresso cup
taza de espresso
10 cl - 3¹/₃ oz 2. 207759 - SOUCOUBE ESPRESSO
espresso saucer
plato espresso
12,5 cm - 5 inch | <ol style="list-style-type: none"> 3. 207757 - TASSE LUNGO
lungo cup
taza de lungo
20 cl - 6²/₃ oz 4. 207760 - SOUCOUBE LUNGO
lungo saucer
plato lungo
15 cm - 5,9 inch | <ol style="list-style-type: none"> 5. 207758 - TASSE DÉJEUNER
breakfast cup
taza desayuno
40 cl - 13¹/₃ oz 6. 207761 - SOUCOUBE DÉJEUNER
breakfast saucer
plato desayuno
18,5 cm - 7,3 inch 7. 207762 - CRÉMIER
cream bowl
lechera
10 cl - 3¹/₃ oz | <ol style="list-style-type: none"> 8. 207763 - VERSEUSE
tea pot
tetera
40 cl - 13¹/₃ oz 9. 207764 - VERSEUSE
tea pot
tetera
80 cl - 26²/₃ oz 10. 210911 - 210912 COUVERCLE VERSEUSE
lid for tea pot
tapa tetera |
|---|---|---|---|



Fabriquée dans le respect de la tradition de la **porcelaine de Limoges**, **Esquisse** n'en est pas moins une création résolument contemporaine pensée pour les professionnels. Caractérisée par une **aile large et un bassin peu profond**, le design à la fois simple et raffiné magnifie la blancheur et la finesse de la porcelaine.

*Manufactured according to the standards of traditional **Limoges porcelain**, **Esquisse** is nonetheless a resolutely contemporary collection intended for professional use.*

*Characterised by a **large rim and a shallow bowl**, the simple yet sophisticated design intensifies the whiteness and delicacy of the porcelain.*

Fabricada respetando la tradición de la **porcelana de Limoges**, **Esquisse** no deja de ser una creación contemporánea pensada para los profesionales.

Caracterizada por **un ala larga y con poca profundidad**, el diseño a la vez simple y refinado magnifica la blancura y la finura de la porcelana.

BORÉAL

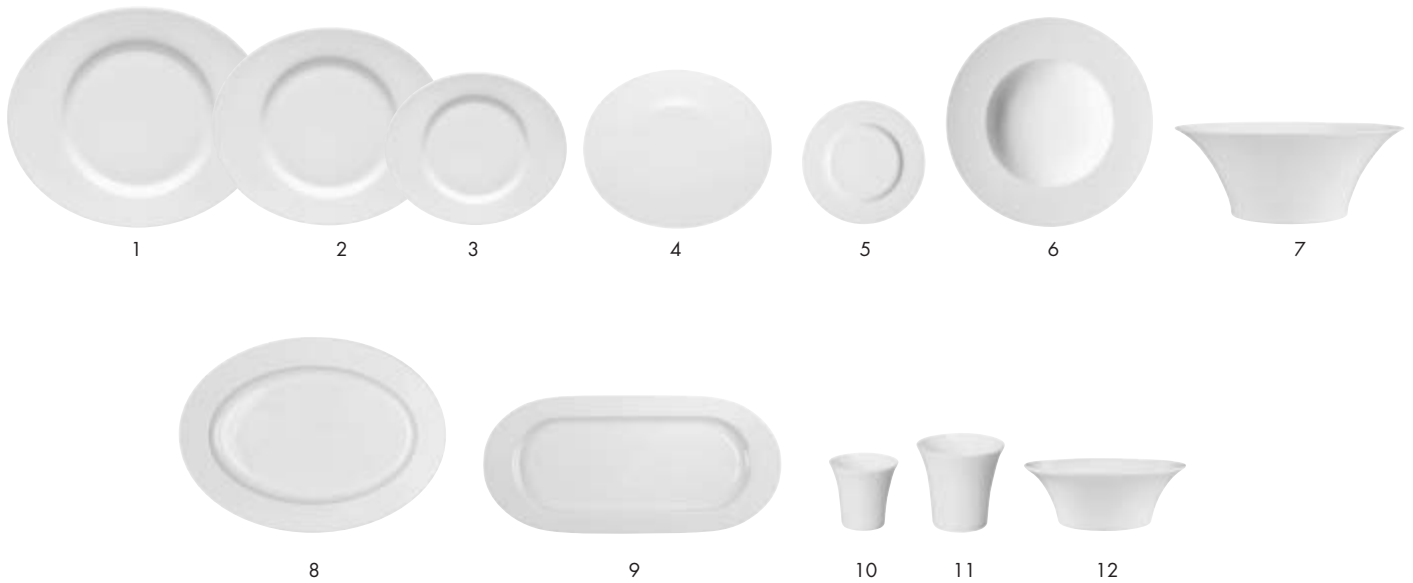

- | | | |
|--|--|---|
| <p>1. 207137 - ASSIETTE DE PRÉSENTATION OVALE
oval presentation plate
plato presentación ovalado
34,5x29 cm - 13,6x11,4 inch</p> | <p>5. 207139 - ASSIETTE À PAIN OVALE
oval bread/butter plate
plato de pan ovalado
16 cm - 6,3 inch</p> | <p>9. 186788 - PLAT À CAKE
cake dish, flat
fuente rectangular
40,5 x 19 cm - 15,9x 7,5 inch</p> |
| <p>2. 207134 - ASSIETTE PLATE OVALE
oval dinner plate
plato ovalado
31x26,5 cm - 12,2x10,4 inch</p> | <p>6. 207140 - ASSIETTE À PÂTES RONDE
soup pasta bowl
plato hondo pasta
29 cm - 11,4 inch</p> | <p>10. 186797 - VERRINE
appetizer
vaso
6 cl - 2 oz</p> |
| <p>3. 207135 - ASSIETTE DESSERT OVALE
oval dessert plate
plato ovalado
24x20,5 cm - 9,4x8,1 inch</p> | <p>7. 186782 - SALADIER
salad bowl deep
ensaladera
28x24 cm - 11x9,4 inch</p> | <p>11. 186851 - VERRINE
appetizer
vaso
12 cl - 4 oz</p> |
| <p>4. 207136 - ASSIETTE CALOTTE OVALE
oval cereal bowl/plate
plato ovalado
23,5x19 cm - 9,3x7,9 inch</p> | <p>8. 200102 - PLAT OVALE CREUX
oval deep dish
plato honda ovalado
36,5 x 26,5 cm - 14,4 x 10,4 inch</p> | <p>12. 186779 - COUPELLE
small bowl
bol
14 x 12 cm - 5,5 x 4,7 inch</p> |

THÉ CAFÉ - TEA COFFEE - TÉ Y CAFÉ BORÉAL P.56



- | | | | |
|---|--|---|--|
| <p>1. 186791 - TASSE CAFÉ
coffee cup
taza de café
9 cl - 3 oz</p> | <p>4. 186794 - SOUCOUBE THÉ
tea saucer
plato tè
16,5x14 cm - 6,5x5,5 inch</p> | <p>7. 186775 - MUG
mug
mug
29 cl - 9²/₃ oz</p> | <p>10. 186777 - SUCRIER
sugar bowl
azucarero
14x12 cm - 5,5x4,7 inch</p> |
| <p>2. 186792 - SOUCOUBE CAFÉ
moka saucer
plato moka
14x12 cm - 5,5x4,7 inch</p> | <p>5. 186795 - TASSE DÉJEUNER
breakfast cup
taza desayuno
40 cl - 13¹/₃ oz</p> | <p>8. 186776 - VERSEUSE
coffee pot
cafetera
140 cl - 46²/₃ oz</p> | <p>11. 187264 - COUVERCLE SUCRIER
lid for sugar bowl
tapa azucarero</p> |
| <p>3. 186793 - TASSE THÉ
tea cup
taza de té
20 cl - 6²/₃ oz</p> | <p>6. 186796 - SOUCOUBE DÉJEUNER
breakfast saucer
plato desayuno
20x17 cl - 7,9x6,7 inch</p> | <p>9. 189942 - COUVERCLE VERSEUSE
lid for coffee pot
tapa cafetera</p> | |

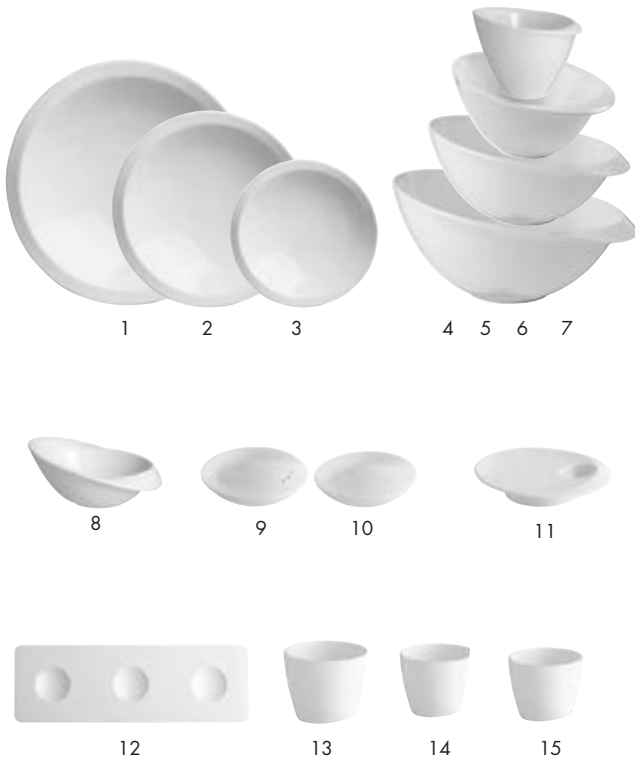

©Julie-Anisau

- | | | | |
|---|---|--|--|
| <p>1. 161012 - ASSIETTE CREUSE
cereal plate
plato hondo
30 cm - 11,8 inch</p> | <p>5. 161015 - SALADIER
salad bowl deep
ensaladera
25 cm - 9,8 inch</p> | <p>9. 161018 - SALIÈRE
salt cellar
salero
6,5 cm - 2,6 inch</p> | <p>13. 198017 - POT SAUCE /GARNITURE
sauce/filling pot
pot
48 cl - 16 oz</p> |
| <p>2. 161011 - ASSIETTE CREUSE
cereal plate
plato hondo
23 cm - 9 inch</p> | <p>6. 161014 - SALADIER/BOL
salad bowl deep
ensaladera
17 cm - 6,5 inch</p> | <p>10. 161019 - POIVRIÈRE
pepper cellar
pimentero
6,5 cm - 2,6 inch</p> | <p>14. 198016 - POT SAUCE /GARNITURE
sauce/filling pot
pot
20 cl - 6²/₃ oz</p> |
| <p>3. 161038 - ASSIETTE PLATE
dinner plate
plato redondo
16 cm - 6,3 inch</p> | <p>7. 161013 - SALADIER/BOL
salad bowl deep
ensaladera
9 cm - 3,5 inch</p> | <p>11. 161020 - COQUETIER
egg cup
huevera
15 cm - 5,9 inch</p> | <p>15. 196561 - POT SAUCE /GARNITURE
sauce/filling pot
pot
8 cl - 2²/₃ oz</p> |
| <p>4. 161016 - SALADIER
salad bowl deep
ensaladera
32 cm - 12,6 inch</p> | <p>8. 161037 - RAVIER
pickle dish
cuenco
10 cm - 3,9 inch</p> | <p>12. 161036 - SUPPORT PLATEAU
tray stand 3 places
fuente con 3 espacios rectangular
30x10 cm - 11,8x3,9 inch</p> | |

THÉ CAFÉ - TEA COFFEE - TÉ Y CAFÉ SMOOS 2.0 P.57

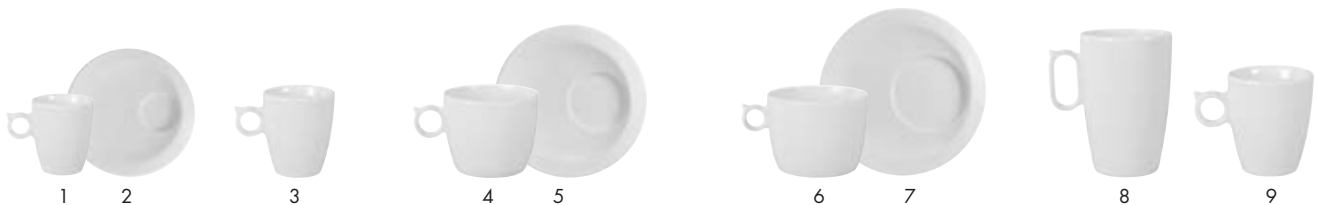

- | | | |
|---|--|---|
| <p>1. 207766 - TASSE ESPRESSO
espresso cup
taza de espresso
6 cl - 2 oz</p> | <p>4. 207767 - TASSE LUNGO
lungo cup
taza de lungo
20 cl - 6²/₃ oz</p> | <p>7. 161034 - SOUCOUBE DÉJEUNER
breakfast cup
taza desayuno
21 cm - 8,3 inch</p> |
| <p>2. 161025 - SOUCOUBE ESPRESSO
espresso saucer
plato espresso
15 cm - 5,9 inch</p> | <p>5. 161028 - SOUCOUBE LUNGO
lungo saucer
plato de lungo
18 cm - 7,1 inch</p> | <p>8. 207765 - MUG
mug
mug
50 cl - 16²/₃ oz</p> |
| <p>3. 208948 - TASSE CAFÉ
coffee cup
taza de café
11 cl - 3²/₃ oz</p> | <p>6. 207768 - TASSE DÉJEUNER
breakfast cup
taza desayuno
48 cl - 16 oz</p> | <p>9. 209189 - MUG
mug
mug
30 cl - 10 oz</p> |





1 CUMIN
1* SESAME
1** PAVOT



2 2* 2**

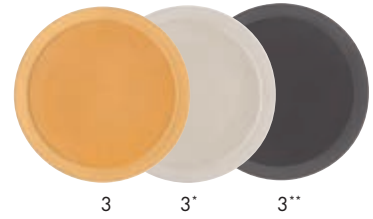

3 3* 3**



4 4* 4**



5 5* 5**



6 6* 6**



8 8* 8**
7 7* 7**

- 213320 - 213333* - 213346** 1. **ASSIETTE PLATE RONDE**
round dinner plate
plato redondo
29 cm - 11,4 inch
- 213319 - 213332* - 213345** 2. **ASSIETTE PLATE RONDE**
round dinner plate
plato redondo
26 cm - 10,2 inch
- 213318 - 213331* - 213344** 3. **ASSIETTE PLATE RONDE**
round dinner plate
plato redondo
23 cm - 9,1 inch
- 213317 - 213330* - 213343** 4. **ASSIETTE À PAIN**
bread/butter plate
plato de pan
14 cm - 5,5 inch

- 213324 - 213337* - 213350** 5. **MINI BOL GOURMET**
gourmet mini bol
mini bol gourmet
7,3 cm - **7 cl** - 2,9 inch - 2^{1/3} oz
- 213325 - 213338* - 213351** 6. **BOL GOURMET**
gourmet bol
bol gourmet
12 cm - **30 cl** - 4,7 inch - 10 oz
- 213326 - 213339* - 213352** 7. **CORPS DE COCOTTE**
casserole body
bol
50 cl - **14 cm** - 16^{2/3} oz - 5,5 inch
- 213327 - 213340* - 213353** 8. **ASSIETTE/COUVERCLE COCOTTE**
plate/lid of casserole
plato/cuerpo cocotte
12,5 cm - 5 inch

THÉ CAFÉ - TEA COFFEE - TÉ Y CAFÉ



1 1* 1**



2 2* 2**



3 3* 3**

- 213328 - 213341* - 213354** 1. **TASSE CAFÉ**
coffee cup
taza de café
11 cl - 3^{2/3} oz

- 214347 - 214348* - 214349** 2. **TASSE THÉ**
tea cup
taza de té
20 cl - 7,9 oz

- 213329 - 213342* - 213355** 3. **MUG À THÉ**
tea mug
mug tetera
38 cl - 12^{2/3} oz

Jeux de contrastes et de couleurs, TERRA ouvre le champ de possibles, jouée seule ou en association avec GOURMET et MODULO. La gamme TERRA fabriquée en céramique teintée masse a des propriétés de résistance mécanique et de porosité de très haute qualité. Les coloris gourmands attisent tous les appétits : un SESAME, blanc grisé subtil, un PAVOT, anthracite léger, et un CUMIN, un ocre chaud qui rehaussera vos présentations.

TERRA range plays on contrasts and colors and opens a wide range of combinations, alone or combined with GOURMET and MODULO. TERRA pieces made in mass colored ceramics present high grade quality for mechanical resistance and porosity. The colors were thought in a greedy spirit: SESAME : a subtle grayish white, PAVOT: a light anthracite, and CUMIN: a warm ochre which will reinforce your presentations.

Juego de contrastes y de colores, TERRA abre el campo de posibilidades, sola o asociada con GOURMET y MODULO. La gama TERRA fabricada en cerámica pintada en masa tiene propiedades de resistencia mecánica y de porosidad de gran calidad. Los colores gastronómicos agudizan cualquier apetito : un SESAME blanco grisáceo sutil, un PAVOT, antracita suave y un CUMIN, un ocre cálido que realzará sus presentaciones.



TERRA

CÉRAMIQUE TEINTÉE MASSE
MASS COLORED CERAMIC
CERÁMICA COLORADO A TODA MESA

new





- | | | | |
|-----------------------------|---|-----------------------------|---|
| 184088 - 184101* - 205273** | 1. PLAT/ ASSIETTE DE PRÉSENTATION
<i>round presentation plate</i>
plato presentación
31,5 cm - 12,2 inch | 184087 - 184100* - 205276** | 6. SALADIER
<i>salad bowl deep</i>
ensaladera
24 cm - 9,4 inch |
| 184077 - 184090* - 205270** | 2. ASSIETTE PLATE RONDE
<i>round dinner plate</i>
plato redondo
28 cm - 11 inch | 184085 - 184098* - 205275** | 7. COUPELLE
<i>small bowl</i>
bol
10 cm - 3,9 inch |
| 184078 - 184091* - 205271** | 3. ASSIETTE DESSERT RONDE
<i>round dessert plate</i>
plato redondo
21 cm - 8,3 inch | 184086 - 184099* - 205274** | 8. COUPE/CALOTTE
<i>cup cereal bowl</i>
bol
17,7 cm - 7 inch |
| 184079 - 184092* - 205272** | 4. ASSIETTE CALOTTE RONDE
<i>round cereal plate</i>
plato hondo
21 cm - 8,3 inch | 190906 - 190910* | 9. MINI COCOTTE
<i>mini casserole</i>
mini cocotte
10 cm - 3,9 inch |
| 209092 - 209093* - 209094** | 5. ASSIETTE À PAIN
<i>bread/butter plate</i>
plato de pan
16 cm - 6,3 inch | 184089 | 10. PLAT RECTANGULAIRE
<i>rectangular dish</i>
fuente rectangular
38x15 cm - 15x5,9 inch |

THÉ CAFÉ - TEA COFFEE - TÉ Y CAFÉ



- | | |
|---|--|
| 1. 184083 - MUG
<i>mug</i>
mug
33 cl - 11 oz | 3. 184084 - BOL DÉJEUNER
<i>breakfast bowl</i>
bol desayuno
14 cm - 5,5 inch - 58 cl - 19 ¹ / ₃ oz |
| 2. 184096 - MUG
<i>mug</i>
mug
33 cl - 11 oz | 4. 184097 - BOL DÉJEUNER
<i>breakfast bowl</i>
bol desayuno
14 cm - 5,5 inch - 58 cl - 19 ¹ / ₃ oz |

MODULO NATURE

GRES/STONEWARE/GRES



4 4* 4**



5 5* 5**



©MUA Photos

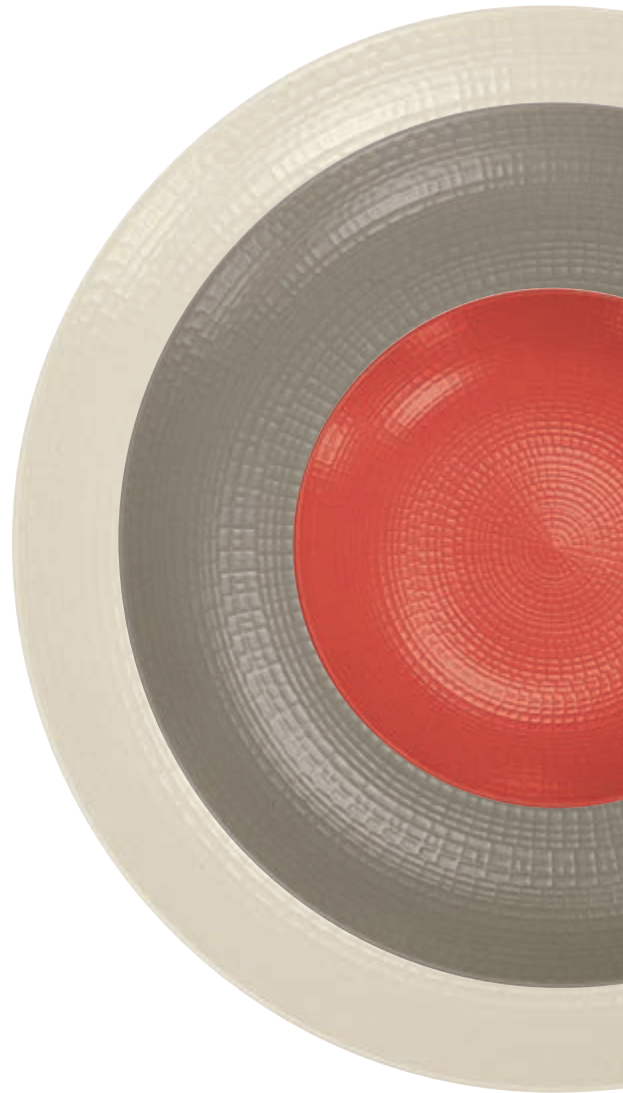

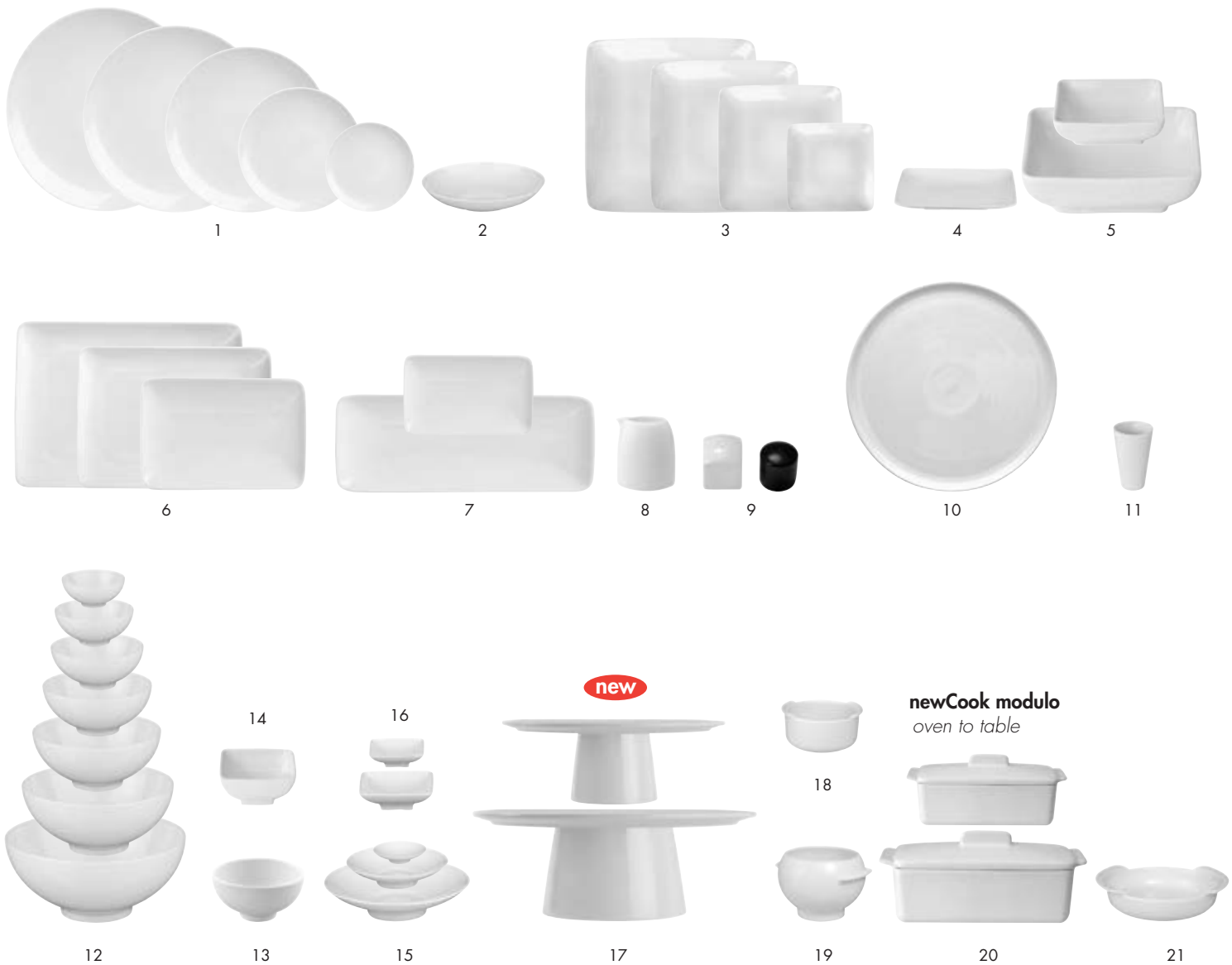

1. ASSIETTES PLATES RONDES

round plates
plato redondo
207120 - 32 cm - 12,6 inch
207112 - 29 cm - 11,4 inch
207113 - 26 cm - 10,2 inch
207111 - 20 cm - 7,9 inch
207119 - 15 cm - 5,9 inch

2. 207114 - ASSIETTE CREUSE RONDE

cereal plate
plato hondo
20 cm - 7,9 inch

3. ASSIETTES PLATES CARRÉES

square plates
plato cuadrado
207118 - 28 cm - 11 inch
207115 - 24 cm - 9,4 inch
207117 - 20 cm - 7,9 inch
207123 - 14 cm - 5,5 inch

4. 207116 - ASSIETTE CREUSE CARRÉE

square soup plate
plato hondo cuadrado
20 cm - 7,9 inch

5. PLATS CREUX CARRÉS

square deep dishes
plato honda cuadrado
149831 - 28 cm - 11 inch
154244 - 16 cm - 6,3 inch

6. ASSIETTES PLATES RECTANGULAIRES

rectangular dinner plates
plato rectangular
181485 - 34x26 cm - 13,4x10,2 inch
207122 - 30x22 cm - 11,8x8,7 inch
207110 - 26x18 cm - 10,2x7,1 inch

7. PLATS RECTANGULAIRES

rectangular dishes
plato rectangular
207754 - 40x16 cm - 15,7x6,3 inch
207753 - 20x12 cm - 7,9x4,7 inch

8. 187277 - CRÉMIER

cream jug
lechera
15 cl - 5¹/₃ oz

9. 182915 - SET SALIÈRE/POIVRIÈRE

set salt/pepper
salero & pimentero

10. 136524 - PLAT À TARTE

pie dish
fuente para pastel
32 cm - 12,6 inch

11. 181490 - VERRINE PORCELAIN

appetizer, porcelain
vasito porcelana
8 cl - 2²/₃ oz

12. BOLS

bowls, deep
bol hondo
142722 - 28 cm - 11 inch
136529 - 24 cm - 9,4 inch
136511 - 20 cm - 7,9 inch
136528 - 16 cm - 6,3 inch
154245 - 14 cm - 5,5 inch
136510 - 12 cm - 4,7 inch
136509 - 8 cm - 3,1 inch

13. 188537 - BOL À SOUPE

bouillon soup bowl
bol hondo
13 cm - 5,1 inch

14. 181483 - BOL CARRÉ

square bowl, deep
bol cuadrado
12 cm - 4,7 inch

15. COUPES RONDES

fruit bowl
bol rondo
136535 - 24 cm - 9,4 inch
136532 - 16 cm - 6,3 inch
136530 - 8 cm - 3,1 inch

16. COUPES CARRÉES

square bowl, coupe
bol cuadrado
136502 - 12 cm - 4,5 inch
136503 - 8 cm - 3,1 inch

17. PRÉSENTOIR GÂTEAUX ROND

round cake stand
plato cake
209382 - 32 cm - 12,6 inch
209381 - 25 cm - 9,8 inch

18. 162015 - RAMEQUIN

ramekin
ramekin
9,5 cm - 3,7 inch

19. 162013 - BOL À CONSOMMÉ

soup bowl
bol consomé
10,5 cm - 4,1 inch

20. 164275 - TERRINE AVEC COUVERCLE

terrine with lid
terrina con tapa
600 g - 21 oz

20. 164276 - TERRINE AVEC COUVERCLE

terrine with lid
terrina con tapa
1 kg - 35 oz

21. 162011 - ASSIETTE À CRÈME BRÛLÉE

«crème brûlée dish»
plato para gratinar
14 cm - 5,5 inch

3 FORMES... + DE 250 SOLUTIONS
3 SHAPES... OVER 250 SOLUTIONS
3 FROMAS... MÁS DE 250 SOLUCIONES

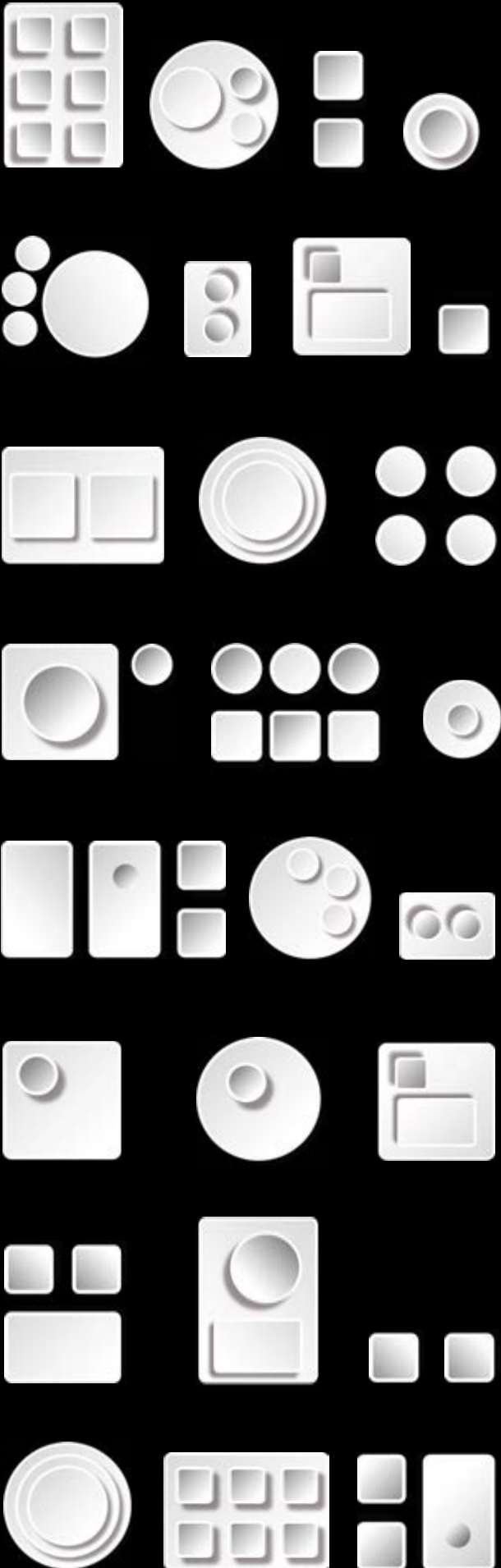

LE THÉ - LE CAFÉ

Le thé et le café sont des univers où le plaisir des sens est décuplé par le plaisir esthétique.

En suivant la même démarche qui fait la force de la marque dans les Arts de la table, Degrenne propose un large choix de tasses, théières et verseuses qui subliment la dégustation pour le plus grand bonheur des amateurs quelque soit le moment ou le lieu.



©Nicolas Broquedis

The sheer sensory pleasure of drinking tea and coffee is further enhanced by the aesthetic nature of the experience.

Adopting the same approach that has made the brand a leading name in tableware, Degrenne offers a wide selection of cups, teapots and coffeepots designed to intensify the taste and enjoyment of connoisseurs, no matter when or where it is served.

Siguiendo la misma línea que supone la fuerza de la marca en las artes de la mesa, Degrenne propone una amplia elección de tazas, teteras y cafeteras que subliman la degustación para un gran placer de los amantes del té y del café independientemente del momento o el lugar donde se sirvan.

S.D. One



1 2



3 4



5



6 7



8 9

1. 187017 - TASSE CAFÉ
coffee cup
taza de café
9 cl - 3 oz

3. 187021 - TASSE THÉ
tea cup
taza de té
25 cl - 8¹/₃ oz

5. 187008 - CRÉMIER
cream jug
lechera
16 cl - 5¹/₃ oz

8. 187006 - THÉIÈRE
tea pot
tetera
100 cl - 33¹/₃ oz

2. 187020 - SOUCOUBE CAFÉ
moka saucer
plato moka
12,5 cm - 5 inch

4. 187022 - SOUCOUBE THÉ
tea saucer
plato tè
14,5 cm - 5,7 inch

6. 187007 - SUCRIER
sugar bowl
azucarero
45 cl - 15 oz

9. 189945 - COUVERCLE THÉIÈRE
lid for tea pot
tapa tetera

7. 189944 - COUVERCLE SUCRIER
lid for sugar bowl
tapa azucarero



NEWPORT



1 2



3 4



5 6



7



8



9

1. 207756 - TASSE ESPRESSO
espresso cup
taza de espresso
10 cl - 3¹/₃ oz

5. 207758 - TASSE DÉJEUNER
breakfast cup
taza desayuno
40 cl - 13¹/₃ oz

9. 207764 - VERSEUSE
tea pot
tetera
80 cl - 26²/₃ oz

2. 207759 - SOUCOUBE ESPRESSO
espresso saucer
plato espresso
12,5 cm - 5 inch

6. 207761 - SOUCOUBE DÉJEUNER
breakfast saucer
plato desayuno
18,5 cm - 7,3 inch

10. 210911 - 210912 COUVERCLE VERSEUSE
lid for tea pot
tapa tetera

3. 207757 - TASSE LUNGO
lungo cup
taza de lungo
20 cl - 6²/₃ oz

7. 207762 - CRÉMIER
cream bowl
lechera
10 cl - 3¹/₃ oz

4. 207760 - SOUCOUBE LUNGO
lungo saucer
plato lungo
15 cm - 5,9 inch

8. 207763 - VERSEUSE
tea pot
tetera
40 cl - 13¹/₃ oz





1. THÉIÈRE 2 TASSES FEUTRE NOIR

tea pot 2 cups
tetera 2 tazas
35 cl - 1 1²/₃ oz

2. CORPS THÉIÈRE 2 TASSES

tea pot 2 cups without lid
cuerpo tetera 2 tazas

004270 - FEUTRE POUR THÉIÈRE 2 TASSES*

tea pot felt 2 cups
fieltro aislante tetera 2 tazas

3. THÉIÈRE 4 TASSES FEUTRE NOIR

tea pot 4 cups
tetera 4 tazas
70 cl - 2 3¹/₃ oz

4. CORPS THÉIÈRE 4 TASSES

tea pot 4 cups without lid
cuerpo tetera 4 tazas

004271 - FEUTRE POUR THÉIÈRE 4 TASSES*

tea pot felt 4 cups
fieltro aislante tetera 4 tazas

5. THÉIÈRE 6 TASSES FEUTRE NOIR

tea pot 6 cups
tetera 6 tazas
100 cl - 3 3¹/₃ oz

6. CORPS THÉIÈRE 6 TASSES

tea pot 6 cups without lid
cuerpo tetera 6 tazas

004272 - FEUTRE POUR THÉIÈRE 6 TASSES*

tea pot felt 6 cups
fieltro aislante tetera 6 tazas

7. THÉIÈRE 8 TASSES FEUTRE NOIR

tea pot 8 cups
tetera 8 tazas
130 cl - 4 3¹/₃ oz

8. CORPS THÉIÈRE 8 TASSES

tea pot 8 cups without lid
cuerpo tetera 8 tazas

004273 - FEUTRE POUR THÉIÈRE 8 TASSES*

tea pot felt 8 cups
fieltro aislante tetera 8 tazas

9. SUCRIER

sugar bowl
azucarero
28 cl - 9¹/₃ oz

10. CORPS SUCRIER

sugar bowl without lid
azucarero

11. CRÉMIER

cream jug
lechera
15 cl - 5 oz

12. INFUSEUR

stainless steel filter
filtro tetera
147992
147994
147993

205135 - BOUCHON

PORCELAINE THÉIÈRE 2/4 T
porcelain lid for tea pot 2/4 c
tapa de porcelana tetera 2/4 t

205136 - BOUCHON

PORCELAINE THÉIÈRE 6/8 T
porcelain lid for tea pot 6/8 c
tapa de porcelana tetera 6/8 t

13. 210946 - TASSE CAFÉ

coffee cup
taza de café
11 cl - 3²/₃ oz

14. 210947 - TASSE THÉ

tea cup
tazo de té
25 cl - 8¹/₃ oz

15. 210950 - SOUCOUBE CAFÉ/THÉ

coffee/tea saucer
plato de café/ té
16 cm - 6,3 inch

16. 210948 - TASSE DÉJEUNER

breakfast cup
taza desayuno/mug
42 cl - 14 oz

17. 210949 - MUG À THÉ

tea mug
mug de té
38 cl - 1 2²/₃ oz

18. 210951 - SOUCOUBE DÉJEUNER/MUG

breakfast/mug saucer
plato desayuno/mug
18 cm - 7,1 inch



Créée en 1953, la théière Salam est le produit emblématique de la marque Degrenne. La finesse de la porcelaine Degrenne alliée à l'éclat de la cloche sublime l'instant thé.

Grâce à sa cloche tapissée d'une feutrine, le thé conserve une température optimale deux fois plus longtemps que dans une théière classique. Un procédé astucieux qui permet au thé de déployer toute la subtilité de ses saveurs au fil de la dégustation.

Created in 1953, Salam teapot is the iconic product of Degrenne. The finesse of Guy Degrenne porcelain combined with the radiance of the outer body enhances the tea experience. With its inner lining of thin felt, the tea inside is kept at its optimum temperature for twice as long as in a regular teapot. This is a clever trick to ensure that the tea is infused with all the subtlety of its flavours as the tasting progresses.

Creada en 1953, la tetera Salam es el producto emblemático de la marca Degrenne. La finura de la porcelana combinada con el brillo del cuerpo de la tetera sublima el instante del té.

Gracias a su tapizado con fieltro, el té conserva una temperatura óptima el doble de tiempo que una tetera clásica. Este ingenioso proceso permite que el té despliegue toda la sutilidad de sus aromas a lo largo de la degustación.



*Pratique, élégante...
La Salam-Thé avec douillette
maintient l'infusion toujours chaude*

BORÉAL



- | | | | |
|---|--|---|--|
| <p>1. 186791 - TASSE CAFÉ
coffee cup
taza de café
9 cl - 3 oz</p> | <p>4. 186794 - SOUCOUBE THÉ OVALE
oval tea saucer
plato tè oval
16,5x14 cm - 6,5x5,5 inch</p> | <p>7. 186775 - MUG
mug
mug
29 cl - 9²/₃ oz</p> | <p>10. 186777 - SUCRIER
sugar bowl
azucarero
14x12 cm - 5,5x4,7 inch</p> |
| <p>2. 186792 - SOUCOUBE CAFÉ OVALE
oval moka saucer
plato moka oval
14x12 cm - 5,5x4,7 inch</p> | <p>5. 186795 - TASSE DÉJEUNER
breakfast cup
taza desayuno
40 cl - 13¹/₃ oz</p> | <p>8. 186776 - VERSEUSE
coffee pot
cafetera
140 cl - 46²/₃ oz</p> | <p>11. 187264 - COUVERCLE SUCRIER
lid for sugar bowl
tapa azucarero</p> |
| <p>3. 186793 - TASSE THÉ
tea cup
taza de té
20 cl - 6²/₃ oz</p> | <p>6. 186796 - SOUCOUBE DÉJEUNER OVALE
oval breakfast saucer
plato desayuno oval
20x17 cl - 7,9x6,7 inch</p> | <p>9. 189942 - COUVERCLE VERSEUSE
lid for coffee pot
tapa cafetera</p> | |

SATIN



- | | | |
|---|---|--|
| <p>1. 186791 - TASSE CAFÉ
coffee cup
taza de café
9 cl - 3 oz</p> | <p>3. 186793 - TASSE THÉ
tea cup
taza de té
20 cl - 6²/₃ oz</p> | <p>5. 186795 - TASSE DÉJEUNER
breakfast cup
taza desayuno
40 cl - 13¹/₃ oz</p> |
| <p>2. 193321 - SOUCOUBE CAFÉ OVALE
oval coffee saucer
plato café oval
14x12 cm - 5,5x4,7 inch</p> | <p>4. 193322 - SOUCOUBE THÉ OVALE
oval tea saucer
plato tè oval
16,5x14 cm - 6,5x5,5 inch</p> | <p>6. 193323 - SOUCOUBE DÉJEUNER OVALE
oval breakfast saucer
plato desayuno oval
20x17 cm - 7,9x6,7 inch</p> |



- | | | |
|--|---|--|
| 1. 207766 - TASSE ESPRESSO
<i>espresso cup</i>
taza de espresso
6 cl - 2 oz | 4. 207767 - TASSE LUNGO
<i>lungo cup</i>
taza de lungo
20 cl - 6²/₃ oz | 7. 161034 - SOUCOUPE DÉJEUNER
<i>breakfast cup</i>
taza desayuno
21 cm - 8,3 inch |
| 2. 161025 - SOUCOUPE ESPRESSO
<i>espresso saucer</i>
plato espresso
15 cm - 5,9 inch | 5. 161028 - SOUCOUPE LUNGO
<i>lungo saucer</i>
plato de lungo
18 cm - 7,1 inch | 8. 207765 - MUG
<i>mug</i>
mug
50 cl - 16²/₃ oz |
| 3. 208948 - TASSE CAFÉ
<i>coffee cup</i>
taza de café
11 cl - 3²/₃ oz | 6. 207768 - TASSE DÉJEUNER
<i>breakfast cup</i>
taza desayuno
48 cl - 16 oz | 9. 208189 - MUG
<i>mug</i>
mug
30 cl - 10 oz |



MODULO COLOR

BOLS

bowls, deep
bol hondo

LIME



207684 - 9 cm - 3,5 inch
207685 - 14 cm - 5,5 inch
207686 - 16 cm - 6,3 inch
207687 - 20 cm - 7,9 inch
207688 - 24 cm - 9,4 inch

MOUSSE



207738 - 9 cm - 3,5 inch
207739 - 14 cm - 5,5 inch
207740 - 16 cm - 6,3 inch
207741 - 20 cm - 7,9 inch
207742 - 24 cm - 9,4 inch

GRENADE



207702 - 9 cm - 3,5 inch
207703 - 14 cm - 5,5 inch
207704 - 16 cm - 6,3 inch
207705 - 20 cm - 7,9 inch
207706 - 24 cm - 9,4 inch

CARBONE



207720 - 9 cm - 3,5 inch
207721 - 14 cm - 5,5 inch
207722 - 16 cm - 6,3 inch
207723 - 20 cm - 7,9 inch
207724 - 24 cm - 9,4 inch



HULAHOOOP

BOL

bowl, deep
bol hondo
14 cm - 5,5 inch
58 cl - 19¹/₃ oz



LIN
194976



CERISE
191043

MUG

mug
mug
37 cl - 12¹/₃ oz



CERISE
194944



LIN
194974



Smoos 2

COLOR

new

LIME



211921 - 211922



211923 - 211924



211925

MOUSSE



211916 - 211917



211918 - 211919



211920

GRENADE



211926 - 211927



211928 - 211929



211930

CARBONE



211931 - 211932



211933 - 211934



211935

TASSE ESPRESSO
espresso cup
 taza de espresso
6 cl - 2 oz

SOUCOUPE ESPRESSO
espresso saucer
 plato espresso
15 cm - 5,9 inch

TASSE LUNGO
lungo cup
 taza de lungo
20 cl - 6²/₃ oz

SOUCOUPE LUNGO
lungo saucer
 plato de lungo
18 cm - 7,1 inch

MUG
mug
 mug
50 cl - 16²/₃ oz



CUTLERY

For decades, the silversmith workshops in Vire in Normandy have been using **their unique expertise in stainless steel work** to shape majestic bobbins of steel and transform the raw material into Guy Degrenne cutlery. Whether created in collaboration with chefs or allowing the designers free rein, classic or contemporary, with sober or more elaborate lines, every model has its own seat on the table. Guy Degrenne cutlery meets criteria of quality, functionality and aesthetics, essential values allowing it to find its place on every table.



CUBIERTOS

Desde décadas, los talleres de orfebre en Vire en Normandía se apoyan **sobre un saber hacer único en el trabajo del acero inoxidable**, para dar forma a las majestuosas bobinas de acero y transformar la materia en bruto en cubiertos Guy Degrenne.

Creado en colaboración con chefs o dando rienda suelta a la imaginación de los diseñadores, ya sea clásico o contemporáneo, con líneas sobrias o más elaboradas, cada modelo tiene su sitio en la mesa.

Los cubiertos Guy Degrenne responden a criterios de calidad, de funcionalidad y de estética, valores esenciales para encontrar su lugar en todas las mesas.

LE COUVERT

Depuis des décennies, les ateliers d'orfèvre à Vire en Normandie s'appuient sur un **savoir-faire unique dans le travail de l'acier inoxydable**, pour donner forme aux majestueuses bobines d'acier et transformer la matière brute en couverts Guy Degrenne.



Créé en collaboration avec des chefs ou en laissant libre cours à l'imagination des designers, qu'il soit classique ou contemporain, aux lignes sobres ou plus élaborées, chaque modèle a sa place à table.

Les couverts Guy Degrenne répondent à des critères de qualité, de fonctionnalité et d'esthétique, des valeurs essentielles pour trouver leur place sur toutes les tables.

 VINTAGE LINE

La collection VINTAGE LINE témoigne du Savoir-Faire historique de la marque Degrenne. L'outillage qui a servi à la fabrication de chaque couvert depuis la naissance de la marque est conservé précieusement et fait partie, au même titre que le Savoir - Faire, de la mémoire de la marque. Aujourd'hui, nous proposons en exclusivité aux professionnels de la restauration sensibles à cet héritage, la réédition VINTAGE des classiques.

La fabrication d'un modèle de la gamme VINTAGE LINE est réalisée sur commande dans un délai de 6 semaines.
L'argenterie est réalisée avec un délai supplémentaire de 2 semaines.

The VINTAGE LINE collection is a demonstration of the Degrenne brand's historic craftsmanship. The equipment used to produce every item of cutlery created since the birth of the brand is carefully preserved and, like our craftsmanship, forms part of the brand's memory. Today, we offer those professionals sensitive to this heritage the exclusive vintage re-edition of these key models that have made their mark on the history of classic models.

La colección VINTAGE LINE da fe del saber hacer histórico de la marca Degrenne. Las herramientas que han servido para la fabricación de cada cubierto desde el nacimiento de la marca están conservadas cuidadosamente y forman parte, por la misma razón que el saber hacer, de la memoria y de la marca. En la actualidad proponemos en exclusividad a los profesionales de la restauración sensibles a esa herencia, la reedición vintage de los modelos emblemáticos que han marcado la historia de los modelos clásicos.

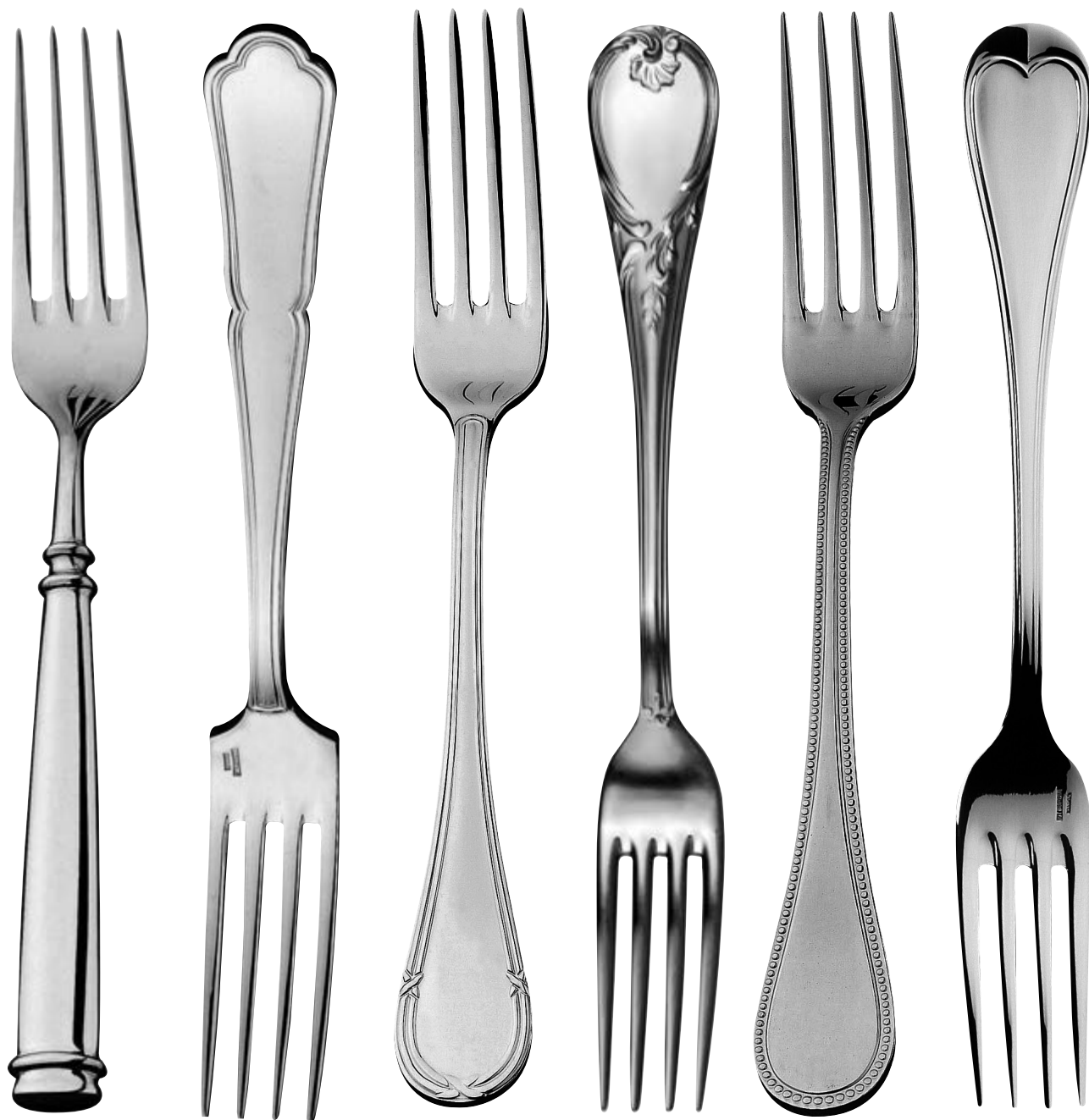

ABSOLU - CONTOUR - FLORENCIA - MARQUISE - MILADY - NEUILLY

1. 126556 - FOURCHETTE DE TABLE

table fork
tenedor mesa
20,2 cm - 7,95 inch



2. 126565 - COUTEAU TABLE MANCHE ORFÈVRE LAME UNIE

table knife hollow handle
cuchillo mesa enmangado hoja lisa
23 cm - 9,06 inch



3. 130332 - COUTEAU TABLE MANCHE ORFÈVRE LAME SCIE

table knife hollow handle serrated
cuchillo mesa enmangado hoja sierra
23 cm - 9,06 inch



4. 126553 - CUILLER TABLE

table /pasta spoon
cuchara mesa
20,5 cm - 8,07 inch



5. 155528 - CUILLER À SOUPE ANGLAISE

bouillon spoon, round
cuchara consomé
17,5 cm - 6,89 inch



6. 126569 - CUILLER DESSERT

dessert/soup spoon, oval
cuchara postre
18,1 cm - 7,1 inch



7. 126572 - FOURCHETTE DESSERT

dessert/salad fork
tenedor postre
18 cm - 7,1 inch



8. 126575 - COUTEAU DESSERT MANCHE ORFÈVRE LAME UNIE

dessert knife heavy hollow handle
cuchillo mesa monobloc hoja lisa
20,5 cm - 8,07 inch



9. 126578 - FOURCHETTE POISSON

fish fork
tenedor pescado
18 cm - 7,1 inch



10. 126581 - COUTEAU POISSON

fish knife
cuchillo pescado
20,1 cm - 7,9 inch



11. 126559 - CUILLER CAFÉ/THÉ

coffee tea spoon
cuchara café-té
13,9 cm - 5,47 inch



12. 155452 - CUILLER MOKA

demi tasse spoon
cuchara moka
11,1 cm - 4,4 inch



13. 126584 - FOURCHETTE GÂTEAUX/COCKTAIL

pastry/cocktail fork
tenedor pastel/cóctel
14 cm - 5,5 inch



14. 154828 - COUTEAU À BEURRE MANCHE ORFÈVRE LAME UNIE

butter knife hollow handle
espatulín mantequilla
18,8 cm - 7,4 inch



15. 126591 - FOURCHETTE DE SERVICE

servicing fork
tenedor de servicio
24,8 cm - 9,76 inch



16. 126589 - CUILLER DE SERVICE

servicing spoon
cuchara de servicio
25 cm - 9,84 inch



17. 126593 - SERVICE SALADE

salad serving set
set servicio/ensalada
26 cm - 10,2 inch



18. 126587 - PELLE À TARTE MANCHE ORFÈVRE

pastry server hollow handle
pala de tarta enmangado
24 cm - 9,45 inch



19. 126562 - LOUCHE

soup ladle
cazo sopa
29,7 cm - 11,69 inch



20. 126595 - CUILLER À SAUCE

sauce ladle
cuchara salsa
17 cm - 6,69 inch



ABSOLU
VINTAGE LINE



1. **126077 - FOURCHETTE DE TABLE**
table fork
tenedor mesa
20,8 cm - 8,2 inch 
2. **190643 - COUTEAU TABLE MONOBLOC LAME SCIE**
table knife solid handle serrated
cuchillo mesa hoja sierra
24,6 cm - 9,7 inch 
3. **130140 - COUTEAU TABLE MANCHE ORFÈVRE LAME SCIE**
table knife hollow handle serrated
cuchillo mesa enmangado hoja sierra
24,6 cm - 9,7 inch 
4. **127654 - COUTEAU STEAK MANCHE ORFÈVRE LAME SCIE**
steak knife hollow handle serrated
cuchillo steak monocasco
23,9 cm - 9,4 inch 
5. **126074 - CUILLER TABLE**
table /pasta spoon
cuchara mesa
20,8 cm - 8,2 inch 
6. **127651 - CUILLER À SOUPE ANGLAISE**
bouillon spoon, round
cuchara consommé
17,4 cm - 6,85 inch 
7. **126090 - CUILLER DESSERT**
dessert /soup spoon, oval
cuchara postre
18 cm - 7,08 inch 
8. **126093 - FOURCHETTE DESSERT**
dessert/salad fork
tenedor postre
17,8 cm - 7,01 inch 
9. **190644 - COUTEAU DESSERT MONOBLOC LAME UNIE**
dessert knife solid handle
cuchillo postre hoja lisa
20,5 cm - 8,1 inch 
10. **126096 - COUTEAU DESSERT MANCHE ORFÈVRE LAME UNIE**
dessert knife heavy hollow handle
cuchillo mesa monobloc hoja lisa
20,5 cm - 8,1 inch 
11. **126099 - FOURCHETTE POISSON**
fish fork
tenedor pescado
17,7 cm - 6,97 inch 
12. **126102 - COUTEAU POISSON**
fish knife
cuchillo pescado
19,9 cm - 7,83 inch 
13. **129958 - CUILLER À SAUCE GOURMET**
gourmet sauce spoon, flat
cuchara salsa/gourmet
17,9 cm - 7,05 inch 
14. **126080 - CUILLER CAFÉ**
coffee tea spoon
cuchara café
14 cm - 5,51 inch 
15. **126105 - CUILLER MOKA**
demi tasse spoon
cuchara moka
11 cm - 4,33 inch 
16. **130146 - CUILLER SODA**
iced tea spoon
cuchara soda
18,2 cm - 7,17 inch 
17. **126108 - FOURCHETTE GÂTEAUX/COCKTAIL**
pastry/cocktail fork
tenedor pastel/cóctel
13,8 cm - 5,43 inch 
18. **190418 - FOURCHETTE À HÛÎTRES**
oyster fork
tenedor ostras
13 cm - 5,12 inch 
19. **183150 - TARTINEUR**
butter spreader
espatulín mantequilla
18 cm - 7,08 inch 
20. **190417 - COUTEAU À BEURRE MONOBLOC LAME UNIE**
butter knife solid handle
espatulín mantequilla hoja lisa
18,7 cm - 7,36 inch 
21. **129344 - COUTEAU À BEURRE MANCHE ORFÈVRE LAME UNIE**
butter knife hollow handle
espatulín mantequilla hoja lisa
18,7 cm - 7,36 inch 
22. **126114 - FOURCHETTE DE SERVICE**
serving fork
tenedor de servicio
24,8 cm - 9,8 inch 

23. 126112 - CUILLER DE SERVICE

servng spoon
cuchara de servicio
25 cm - 9,84 inch



24. 126116 - SERVICE SALADE

salad serving set
set servicio/ensalada
25,8 cm - 10,16 inch



25. 126111 - PELLE À TARTE

pastry server
pala de tarta
24,9 cm - 9,8 inch



26. 126083 - LOUCHE

soup ladle
cazo sopa
29,8 cm - 11,73 inch



27. 126118 - CUILLER À SAUCE

sauce ladle
cuchara salsa
15,7 cm - 6,18 inch



FLORENCIA

VINTAGE LINE

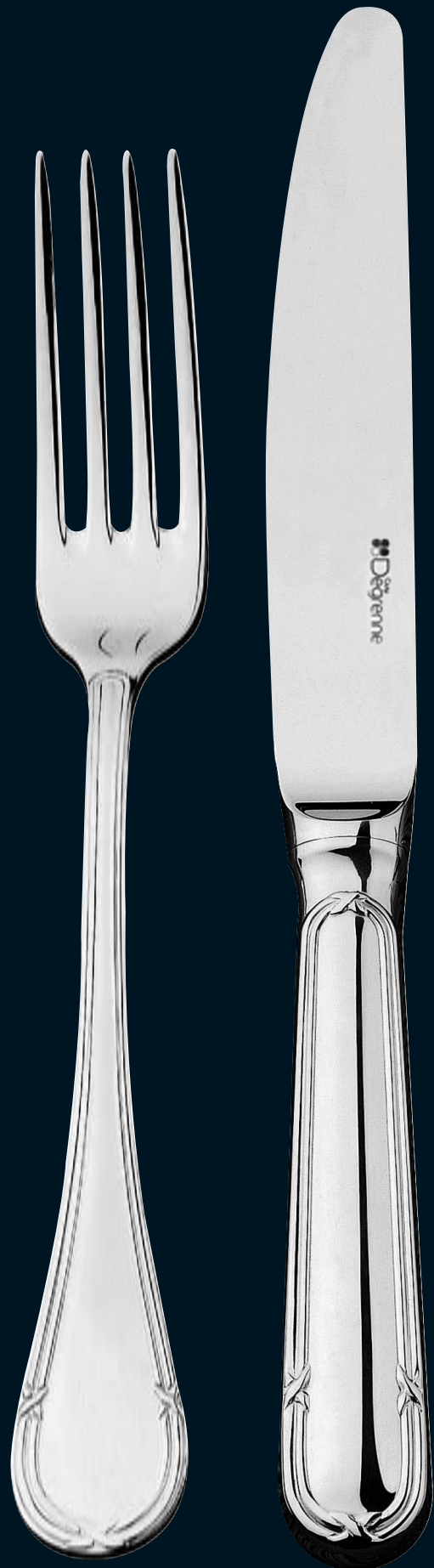

INTERNATIONAL RANGE



1. 104729 - FOURCHETTE DE TABLE

table fork
tenedor mesa
21 cm - 8,27 inch



2. 104728 - COUTEAU TABLE MANCHE ORFÈVRE LAME SCIE

table knife hollow handle serrated
cuchillo mesa enmangado hoja sierra
25 cm - 9,84 inch



3. 186293 - COUTEAU STEAK MANCHE ORFÈVRE LAME SCIE

steak knife hollow handle serrated
cuchillo steak monocasco
23,1 cm - 9,09 inch



4. 104712 - CUILLER TABLE

table /pasta spoon
cuchara mesa
21 cm - 8,27 inch



5. 186291 - CUILLER À SOUPE ANGLAISE

bouillon spoon, round
cuchara consomé
17,4 cm - 6,85 inch



6. 104752 - CUILLER DESSERT

dessert /soup spoon, oval
cuchara postre
18,2 cm - 7,17 inch



7. 104765 - FOURCHETTE DESSERT

dessert/salad fork
tenedor postre
18,1 cm - 7,13 inch



8. 104779 - COUTEAU DESSERT MANCHE ORFÈVRE LAME UNIE

dessert knife heavy hollow handle
cuchillo mesa monobloc hoja lisa
21 cm - 8,27 inch



9. 104707 - FOURCHETTE POISSON

fish fork
tenedor pescado
17,9 cm - 7,05 inch



10. 104727 - COUTEAU POISSON

fish knife
cuchillo pescado
20 cm - 7,87 inch



11. 186292 - CUILLER À SAUCE GOURMET

gourmet sauce spoon, flat
cuchara salsa/gourmet
18,2 cm - 7,17 inch



12. 104766 - CUILLER CAFÉ

coffee tea spoon
cuchara café
14,4 cm - 5,67 inch



13. 104764 - CUILLER MOKA

demi tasse spoon
cuchara moka
11,5 cm - 4,53 inch



14. 186290 - FOURCHETTE GÂTEAUX/COCKTAIL

pastry/cocktail fork
tenedor pastel/côctel
14 cm - 5,51 inch



15. 186294 - COUTEAU À BEURRE MANCHE ORFÈVRE LAME UNIE

butter knife hollow handle
espatulín mantequilla hoja lisa
19,2 cm - 7,56 inch



16. 001405 - FOURCHETTE DE SERVICE

servicing fork
tenedor de servicio
24,7 cm - 9,72 inch



17. 001406 - CUILLER DE SERVICE

servicing spoon
cuchara de servicio
24,8 cm - 9,76 inch



18. 040643 - SERVICE SALADE

salad serving set
set servicio/ensalada
25,9 cm - 10,20 inch



19. 083362 - PELLE À TARTE

pastry server
pala de tarta
25 cm - 9,84 inch



20. 097728 - LOUCHE

soup ladle
cazo sopa
30,6 cm - 12,05 inch



21. 001398 - CUILLER À SAUCE

sauce ladle
cuchara salsa
15,8 cm - 6,22 inch



CONTOUR

VINTAGE LINE



1. 182968 - FOURCHETTE DE TABLE

table fork
tenedor mesa
20,8 cm - 8,19 inch



2. 182970 - COUTEAU TABLE MANCHE ORFÈVRE LAME SCIE

table knife hollow handle serrated
cuchillo mesa enmangado hoja sierra
24,6 cm - 9,69 inch



3. 186278 - COUTEAU STEAK MANCHE ORFÈVRE LAME SCIE

steak knife hollow handle serrated
cuchillo steak monocasco
23,9 cm - 9,41 inch



4. 182967 - CUILLER TABLE

table /pasta spoon
cuchara mesa
20,8 cm - 8,19 inch



5. 186276 - CUILLER À SOUPE ANGLAISE

bouillon spoon, round
cuchara consomé
17,4 cm - 6,85 inch



6. 182974 - CUILLER DESSERT

dessert /soup spoon, oval
cuchara postre
18 cm - 7,09 inch



7. 182975 - FOURCHETTE DESSERT

dessert/salad fork
tenedor postre
17,8 cm - 7,01 inch



8. 182971 - COUTEAU DESSERT MANCHE ORFÈVRE LAME UNIE

dessert knife heavy hollow handle
cuchillo mesa monobloc hoja lisa
20,5 cm - 8,07 inch



9. 182972 - FOURCHETTE POISSON

fish fork
tenedor pescado
17,7 cm - 6,97 inch



10. 182973 - COUTEAU POISSON

fish knife
cuchillo pescado
19,9 cm - 7,83 inch



11. 186277 - CUILLER À SAUCE GOURMET

gourmet sauce spoon, flat
cuchara salsa/gourmet
17,9 cm - 7,05 inch



12. 182969 - CUILLER CAFÉ

coffee tea spoon
cuchara café
14 cm - 5,51 inch



13. 182976 - CUILLER MOKA

demi tasse spoon
cuchara moka
11 cm - 4,33 inch



14. 186275 - CUILLER SODA

demi tasse spoon
cuchara moka
18,2 cm - 7,17 inch



15. 186274 - FOURCHETTE GÂTEAUX/COCKTAIL

pastry/cocktail fork
tenedor pastel/cóctel
13,8 cm - 5,43 inch



16. 190681 - FOURCHETTE À HÛÎTRES

oyster fork
tenedor ostras
13 cm - 5,12 inch



17. 186279 - COUTEAU À BEURRE MANCHE ORFÈVRE LAME UNIE

butter knife hollow handle
espatulín mantequilla hoja lisa
18,7 cm - 7,36 inch



18. 183803 - FOURCHETTE DE SERVICE

servicing fork
tenedor de servicio
24,8 cm - 9,76 inch



19. 183802 - CUILLER DE SERVICE

servicing spoon
cuchara de servicio
25 cm - 9,84 inch



20. 190682 - LOUCHE

soup ladle
cazo sopa
29,8 cm - 11,73 inch



21. 183804 - CUILLER À SAUCE

sauce ladle
cuchara salsa
15,7 cm - 6,18 inch



MARQUISE

VINTAGE LINE



1. 127442 - FOURCHETTE DE TABLE

table fork
tenedor mesa
20,8 cm - 8,19 inch



2. 139158 - COUTEAU TABLE MANCHE ORFÈVRE LAME SCIE

table knife hollow handle serrated
cuchillo mesa enmangado hoja sierra
24,6 cm - 9,69 inch



3. 128841 - COUTEAU STEAK MANCHE ORFÈVRE LAME SCIE

steak knife hollow handle serrated
cuchillo steak monocasco
23,9 cm - 9,41 inch



4. 127439 - CUILLER TABLE

table /pasta spoon
cuchara mesa
20,8 cm - 8,19 inch



5. 130273 - CUILLER À SOUPE ANGLAISE

bouillon spoon, round
cuchara consomé
17,4 cm - 6,85 inch



6. 127464 - CUILLER DESSERT

dessert /soup spoon, oval
cuchara postre
18 cm - 7,08 inch



7. 127467 - FOURCHETTE DESSERT

dessert/salad fork
tenedor postre
17,8 cm - 7,01 inch



8. 127470 - COUTEAU DESSERT MANCHE ORFÈVRE LAME UNIE

dessert knife heavy hollow handle
cuchillo mesa monobloc hoja lisa
20,5 cm - 8,07 inch



9. 127473 - FOURCHETTE POISSON

fish fork
tenedor pescado
17,7 cm - 6,97 inch



10. 127477 - COUTEAU POISSON

fish knife
cuchillo pescado
19,9 cm - 7,83 inch



11. 130542 - CUILLER À SAUCE GOURMET

gourmet sauce spoon, flat
cuchara salsa/gourmet
17,9 cm - 7,05 inch



12. 127455 - CUILLER CAFÉ

coffee tea spoon
cuchara café
14 cm - 5,51 inch



13. 127479 - CUILLER MOKA

demi tasse spoon
cuchara moka
11 cm - 4,33 inch



14. 130269 - CUILLER SODA

iced tea spoon
cuchara soda/helado
18,2 cm - 7,17 inch



15. 127482 - FOURCHETTE GÂTEAUX/COCKTAIL

pastry/cocktail fork
tenedor pastel/cóctel
13,8 cm - 5,43 inch



16. 130266 - FOURCHETTE À HÛÎTRES

oyster fork
tenedor ostras
13 cm - 5,12 inch



17. 122769 - COUTEAU À BEURRE MANCHE ORFÈVRE LAME UNIE

butter knife hollow handle
espatulín mantequilla hoja lisa
18,7 cm - 7,36 inch



18. 127487 - FOURCHETTE DE SERVICE

servicing fork
tenedor de servicio
24,8 cm - 9,76 inch



19. 127486 - CUILLER DE SERVICE

servicing spoon
cuchara de servicio
25 cm - 9,84 inch



20. 127488 - SERVICE SALADE

salad serving set
set servicio/ensalada
25,8 cm - 10,16 inch



21. 127485 - PELLE À TARTE

pastry server
pala de tarta
24,9 cm - 9,8 inch



22. 127457 - LOUCHE
soup ladle
cazo sopa
29,8 cm - 11,73 inch



23. 127490 - CUILLER À SAUCE
sauce ladle
cuchara salsa
15,7 cm - 6,18 inch

























MILADY VINTAGE LINE



INTERNATIONAL RANGE



1. **105278 - FOURCHETTE DE TABLE**
table fork
tenedor mesa
20,8 cm - 8,19 inch 
2. **105274 - COUTEAU TABLE MANCHE ORFÈVRE LAME SCIE**
table knife hollow handle serrated
cuchillo mesa enmangado hoja sierra
24,6 cm - 9,69 inch 
3. **186271 - COUTEAU STEAK MANCHE ORFÈVRE LAME SCIE**
steak knife hollow handle serrated
cuchillo steak monocasco hoja sierra
23,9 cm - 9,41 inch 
4. **105310 - CUILLER TABLE**
table /pasta spoon
cuchara mesa
20,8 cm - 8,19 inch 
5. **105288 - CUILLER À SOUPE ANGLAISE**
bouillon spoon, round
cuchara consomé
17,4 cm - 6,85 inch 
6. **105294 - CUILLER DESSERT**
dessert /soup spoon, oval
cuchara postre
18 cm - 7,08 inch 
7. **105290 - FOURCHETTE DESSERT**
dessert/salad fork
tenedor postre
17,8 cm - 7,01 inch 
8. **105305 - COUTEAU DESSERT MANCHE ORFÈVRE LAME UNIE**
dessert knife heavy hollow handle
cuchillo postre monobloc hoja lisa
20,5 cm - 8,07 inch 
9. **105277 - FOURCHETTE POISSON**
fish fork
tenedor pescado
17,7 cm - 6,97 inch 
10. **105276 - COUTEAU POISSON**
fish knife
cuchillo pescado
19,9 cm - 7,83 inch 
11. **105303 - CUILLER CAFÉ**
coffee tea spoon
cuchara café
14 cm - 5,51 inch 
12. **105293 - CUILLER MOKA**
demi tasse spoon
cuchara moka
11 cm - 4,33 inch 
13. **124249 - CUILLER SODA**
iced tea spoon
cuchara soda/helado
18,2 cm - 7,17 inch 
14. **105295 - FOURCHETTE GÂTEAUX/COCKTAIL**
pastry/cocktail fork
tenedor pastel/cóctel
13,8 cm - 5,43 inch 
15. **105275 - FOURCHETTE À HÛÎTRES**
oyster fork
tenedor ostras
13 cm - 5,12 inch 
16. **122747 - COUTEAU À BEURRE MANCHE ORFÈVRE LAME UNIE**
butter knife hollow handle
espatulín mantequilla hoja lisa
18,7 cm - 7,36 inch 
17. **009657 - FOURCHETTE DE SERVICE**
serving fork
tenedor de servicio
24,8 cm - 9,76 inch 
18. **009658 - CUILLER DE SERVICE**
serving spoon
cuchara de servicio
25 cm - 9,84 inch 
19. **009651 - SERVICE SALADE**
salad serving set
set servicio/ensalada
25,8 cm - 10,16 inch 
20. **008929- PELLE À TARTE**
pastry server
pala de tarta
24,9 cm - 9,8 inch 
21. **097730 - LOUCHE**
soup ladle
cazo sopa
29,8 cm - 11,73 inch 
22. **009655 - CUILLER À SAUCE**
sauce ladle
cuchara salsa
15,7 cm - 6,18 inch 

NEUILLY
VINTAGE LINE



INTERNATIONAL RANGE







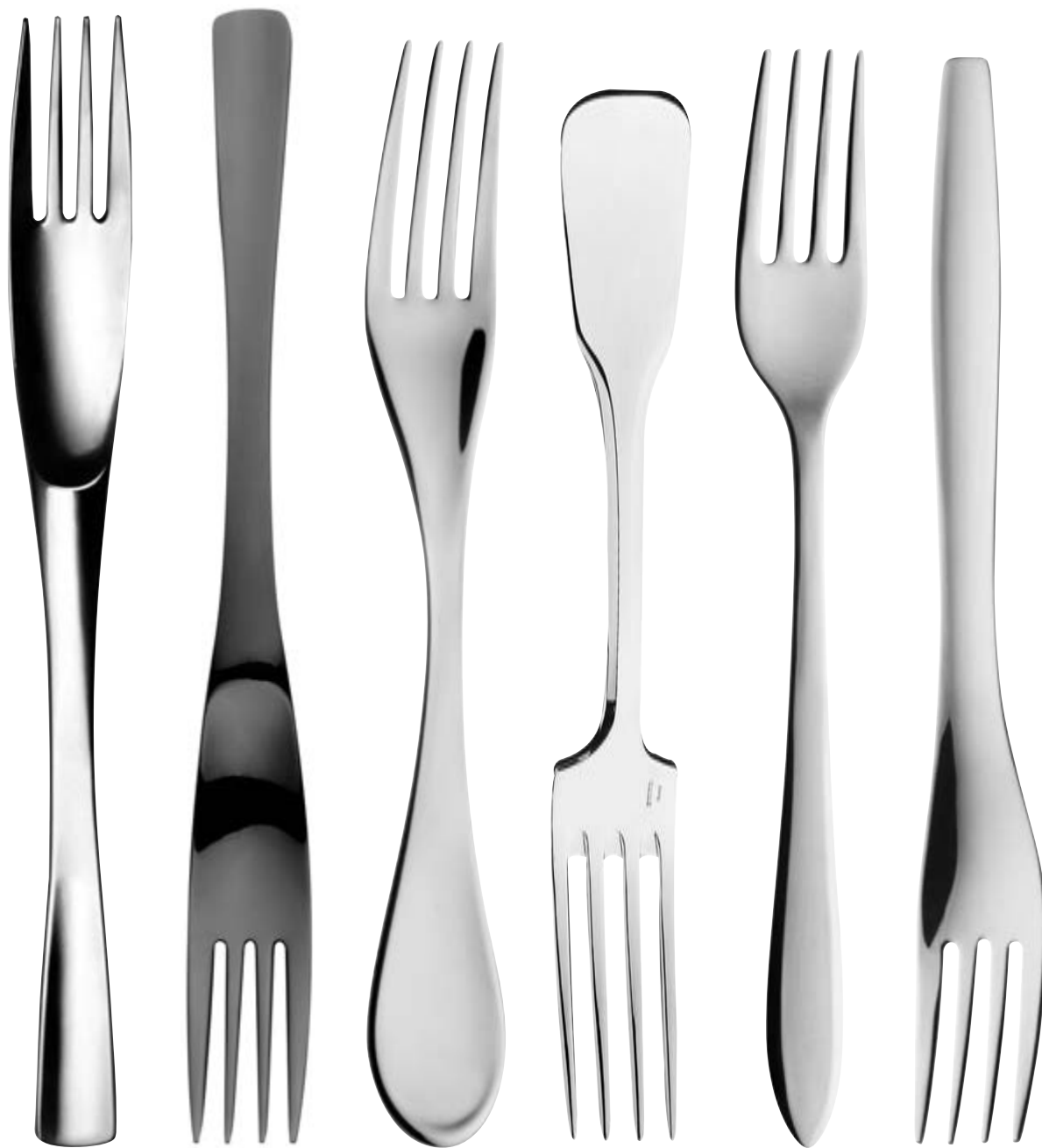



















SOLSTICE SWING - GUEST STAR - SQUADRO - ASTRÉE CISELÉ



XY - XY BLACK - ISATIS - LUTÈCE - NORWAY - SILLAGES

1. **205568 - FOURCHETTE DE TABLE**
table fork
tenedor mesa
21,3 cm - 8,39 inch 
2. **195028 - COUTEAU TABLE MONOBLOC LAME SCIE**
table knife heavy solid handle serrated
cuchillo mesa monobloc hoja sierra
23,3 cm - 9,17 inch 
3. **205569 - CUILLER TABLE**
table /pasta spoon
cuchara mesa
20,5 cm - 8,07 inch 
4. **200483 - CUILLER À SOUPE ANGLAISE**
bouillon spoon, round
cuchara consomé
18,5 cm - 7,28 inch 
5. **205575 - CUILLER GOURMANDE**
dessert /soup spoon, oval
cuchara postre
18,6 cm - 7,32 inch 
6. **205574 - FOURCHETTE GOURMANDE**
dessert fork
tenedor postre
18,6 cm - 7,32 inch 
7. **195031 - COUTEAU DESSERT MONOBLOC LAME UNIE**
dessert knife heavy solid handle
cuchillo mesa monobloc hoja lisa
20,6 cm - 8,11 inch 
8. **205571 - FOURCHETTE POISSON**
fish fork
tenedor pescado
20 cm - 7,87 inch 
9. **205572 - SPATULE GOURMET**
gourmet spatula
espátula gourmet
20,2 cm - 7,95 inch 
10. **205573 - FOURCHETTE GOURMET**
gourmet fork
tenedor gourmet
20 cm - 7,87 inch 
11. **205570 - CUILLER CAFÉ**
coffee tea spoon
cuchara café
14,3 cm - 5,6 inch 
12. **195034 - CUILLER MOKA**
demi tasse spoon
cuchara moka
11 cm - 4,33 inch 
13. **196674 - CUILLER SODA**
iced tea spoon
cuchara soda
19 cm - 7,48 inch 
14. **195039 - FOURCHETTE MISE EN BOUCHE**
appetizer fork
tenedor caracoles
15,5 cm - 6,1 inch 
15. **195042 - SPATULE MISE EN BOUCHE**
appetizer spatula
espátula aperitivo
15,5 cm - 6,1 inch 
16. **195041 - CUILLER MISE EN BOUCHE**
appetizer fork
tenedor caracoles
11,6 cm - 4,57 inch 
17. **196014 - FOURCHETTE À HÛÎTRES**
oyster fork
tenedor ostras
14,1 cm - 5,55 inch 
18. **195036 - TARTINEUR**
butter spreader
espátula mantequilla
16 cm - 6,3 inch 
19. **199773 - FOURCHETTE DE SERVICE**
serving fork
tenedor de servicio
26 cm - 10,2 inch 
20. **199774 - CUILLER DE SERVICE**
serving spoon
cuchara de servicio
26 cm - 10,2 inch 
21. **199679 - SPATULE DE SERVICE**
serving spatula
espátula servicio
25 cm - 9,84 inch 
22. **199671 - SERVICE SALADE**
salad serving set
set servicio/ensalada
30 cm - 11,81 inch 

XY BLACK



©Julie Anstau

L'abus d'alcool est dangereux pour la santé, à consommer avec modération. Alcohol is dangerous for your health, drink with moderation. El abuso del alcohol es peligroso para la salud, consúmese con moderación.

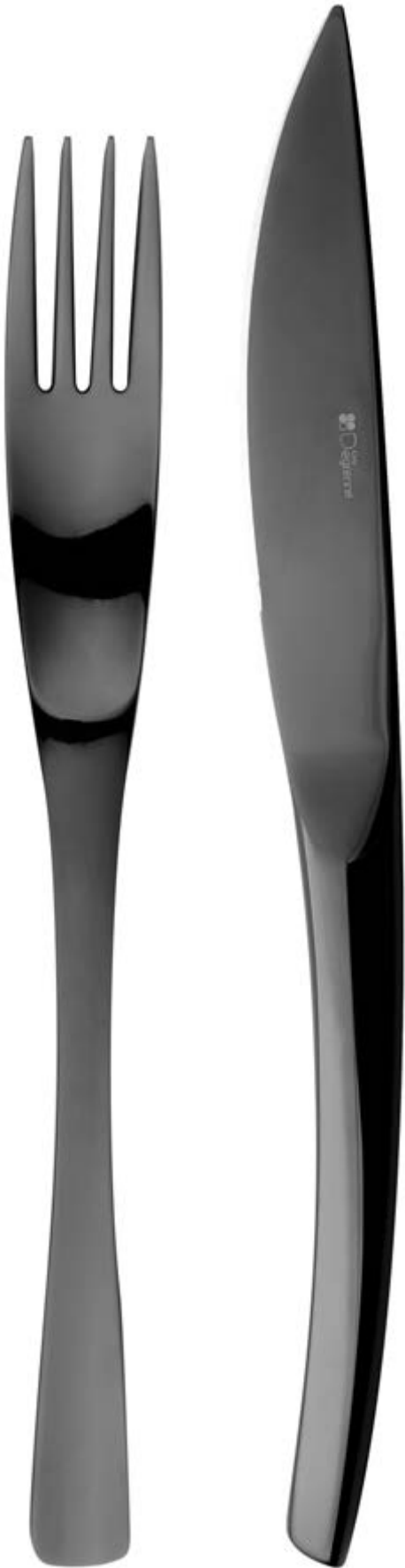

1. 143770 - FOURCHETTE DE TABLE

table fork
tenedor mesa
20,9 cm - 8,23 inch



2. 143778 - COUTEAU TABLE MONOBLOC LAME SCIE

table knife solid handle serrated
cuchillo mesa hoja sierra
23,5 cm - 9,25 inch



3. 195764 - COUTEAU STEAK MONOBLOC LAME SCIE

steak knife solid handle serrated
cuchillo mesa hoja sierra
23,5 cm - 9,25 inch



4. 143767 - CUILLER TABLE

table /pasta spoon
cuchara mesa
21,2 cm - 8,35 inch



5. 148852 - CUILLER À SOUPE ANGLAISE

bouillon spoon, round
cuchara consomé
17,1 cm - 6,73 inch



6. 143801 - CUILLER DESSERT

dessert /soup spoon, oval
cuchara postre
18,7 cm - 7,36 inch



7. 143804 - FOURCHETTE DESSERT

dessert/salad fork
tenedor postre
18,4 cm - 7,24 inch



8. 143787 - COUTEAU DESSERT MONOBLOC LAME UNIE

dessert knife heavy solid handle
cuchillo mesa monobloc hoja lisa
20,7 cm - 8,15 inch



9. 143790 - FOURCHETTE POISSON

fish fork
tenedor pescado
18,5 cm - 7,28 inch



10. 181467 - COUTEAU POISSON /GOURMET

gourmet/fish knife
cuchillo pescado
20,1 cm - 7,91 inch



11. 143772 - CUILLER CAFÉ

coffee tea spoon
cuchara café
14,9 cm - 5,87 inch



12. 148855 - CUILLER MOKA

demi tasse spoon
cuchara moka
11 cm - 4,33 inch



13. 195645 - CUILLER SODA

iced tea spoon
cuchara soda
19 cm - 7,48 inch



14. 198494 - CUILLER À GLACE

ice spoon
cuchara helado
18,9 cm - 7,44 inch



15. 143782 - FOURCHETTE GÂTEAUX/COCKTAIL

pastry/cocktail fork
tenedor pastel/cóctel
14,9 cm - 5,87 inch



16. 195736 - FOURCHETTE À HÛÎTRES

oyster fork
tenedor ostras
14,1 cm - 5,6 inch



17. 181112 - TARTINEUR

butter spreader
espatulín mantequilla
16 cm - 6,3 inch



18. 143795 - FOURCHETTE DE SERVICE

servicing fork
tenedor de servicio
27,9 cm - 10,98 inch



19. 143794 - CUILLER DE SERVICE

servicing spoon
cuchara de servicio
28,2 cm - 11,10 inch



20. 143798 - SERVICE SALADE

salad serving set
set servicio/ensalada
28,2 cm - 11,10 inch



21. 143784 - PELLE À TARTE MONOBLOC

pastry server
pala de tarta
25 cm - 9,84 inch



22. 143775 - LOUCHE

soup ladle
cazo sopa
28,2 cm - 11,10 inch



SERENITY

23. 143806 - CUILLER À SAUCE
sauce ladle
cuchara salsa
17 cm - 6,69 inch



INTERNATIONAL RANGE



©Julie-Ansiau L'abus d'alcool est dangereux pour la santé, à consommer avec modération. Alcohol is dangerous for your health, drink with moderation. El abuso del alcohol es peligroso para la salud, consúmase con moderación.

1. 205533 - FOURCHETTE DE TABLE

table fork
tenedor mesa
20,7 cm - 8,15 inch



2. 201491 - COUTEAU TABLE MANCHE ORFÈVRE LAME UNIE

table knife hollow handle
cuchillo mesa enmangado hoja lisa
23,3 cm - 9,17 inch



3. 199160 - COUTEAU TABLE MANCHE ORFÈVRE LAME SCIE

table knife hollow handle serrated
cuchillo mesa enmangado hoja sierra
23,3 cm - 9,17 inch



4. 205534 - CUILLER TABLE

table /pasta spoon
cuchara mesa
20,7 cm - 8,15 inch



5. 205535 - CUILLER À SOUPE ANGLAISE

bouillon spoon, round
cuchara consomé
17,7 cm - 6,97 inch



6. 205539 - CUILLER DESSERT

dessert /soup spoon, oval
cuchara postre
18,2 cm - 7,17 inch



7. 205538 - FOURCHETTE DESSERT

dessert/salad fork
tenedor postre
18,2 cm - 7,17 inch



8. 199164 - COUTEAU DESSERT MANCHE ORFÈVRE LAME UNIE

dessert knife heavy hollow handle
cuchillo mesa monobloc hoja lisa
20,6 cm - 8,11 inch



9. 205536 - FOURCHETTE POISSON

fish fork
tenedor pescado
18,2 cm - 7,17 inch



10. 205537 - COUTEAU POISSON

fish knife
cuchillo pescado
21,2 cm - 8,35 inch



11. 199159 - CUILLER CAFÉ

coffee tea spoon
cuchara café
14,1 cm - 5,55 inch



12. 199161 - CUILLER MOKA

demi tasse spoon
cuchara moka
11,2 cm - 4,41 inch



13. 199169 - CUILLER SODA

iced tea spoon
cuchara soda
18,8 cm - 7,40 inch



14. 199167 - FOURCHETTE GÂTEAUX/COCKTAIL

pastry/cocktail fork
tenedor pastel/cóctel
14,2 cm - 5,59 inch



15. 199170 - COUTEAU À BEURRE MANCHE ORFÈVRE LAME UNIE

butter knife hollow handle
espatulín mantequilla
18,5 cm - 7,28 inch



16. 199172 - FOURCHETTE DE SERVICE

servicing fork
tenedor de servicio
25 cm - 9,84 inch



17. 199171 - CUILLER DE SERVICE

servicing spoon
cuchara de servicio
25 cm - 9,84 inch



18. 199173 - PELLE À TARTE MANCHE PLAT

pastry server
pala de tarta
23,9 cm - 9,4 inch



19. 199174 - LOUCHE

soup ladle
cazo sopa
30,2 cm - 11,89 inch



SQUADRO



Squadro revisite les codes de l'art déco pour offrir un couvert aux lignes pures et équilibrée. La fourchette 3 dents souligne son caractère affirmé.

Squadro collection flatware revisits Art deco with pure and perfectly balanced lines. 3 prong fork

Tenedor de 3 puntas

1. 202993 - FOURCHETTE DE TABLE

table fork
tenedor mesa
21,3 cm - 8,39 inch



2. 202995 - COUTEAU TABLE MONOBLOC LAME SCIE

table knife solid handle serrated
cuchillo mesa hoja sierra
23,2 cm - 9,1 inch



3. 203017 - COUTEAU STEAK MONOBLOC LAME SCIE

steak knife solid handle serrated
cuchillo steak hoja sierra
23,2 cm - 9,1 inch



4. 202992 - CUILLER TABLE

table /pasta spoon
cuchara mesa
21,6 cm - 8,5 inch



5. 203014 - CUILLER À SOUPE ANGLAISE

bouillon spoon, round
cuchara consomé
18,5 cm - 7,28 inch



6. 203008 - CUILLER DESSERT

dessert /soup spoon, oval
cuchara postre
19,5 cm - 7,68 inch



7. 203007 - FOURCHETTE DESSERT

dessert/salad fork
tenedor postre
19,2 cm - 7,56 inch



8. 210630 - COUTEAU DESSERT MONOBLOC LAME SCIE

dessert knife solid handle serrated
cuchillo mesa hoja sierra
20,9 cm - 8,23 inch



new

9. 203010 - FOURCHETTE POISSON

fish fork
tenedor pescado
19,2 cm - 7,56 inch



10. 203011 - COUTEAU POISSON/GOURMET

gourmet/fish knife
cuchillo pescado
21,3 cm - 8,39 inch



11. 202994 - CUILLER CAFÉ

coffee tea spoon
cuchara café
14,3 cm - 5,63 inch



12. 203006 - CUILLER MOKA

demi tasse spoon
cuchara moka
11,7 cm - 4,61 inch



13. 203015 - CUILLER SODA

iced tea spoon
cuchara soda/helado
18,9 cm - 7,44 inch



14. 203012 - FOURCHETTE GÂTEAUX/COCKTAIL

pastry/cocktail fork
tenedor pastel/cóctel
13,9 cm - 5,47 inch



15. 203013 - FOURCHETTE À HÛÎTRES

snail fork
tenedor ostras
14,1 cm - 5,55 inch



16. 203016 - COUTEAU À BEURRE MONOBLOC LAME UNIE

butter knife solid handle
espatulín mantequilla
19,3 cm - 7,6 inch



17. 203018 - FOURCHETTE DE SERVICE

servicing fork
tenedor de servicio
26,6 cm - 10,47 inch



18. 203019 - CUILLER DE SERVICE

servicing spoon
cuchara de servicio
27 cm - 10,63 inch



19. 203021 - SERVICE SALADE

salad serving set
set servicio/ensalada
30 cm - 11,8 inch

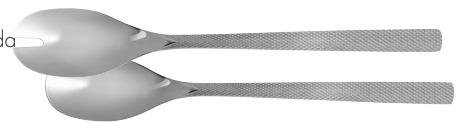

20. 203023 - PELLE À TARTE MANCHE PLAT

pastry server
pala de tarta
25,1 cm - 9,88 inch



21. 203020 - LOUCHE

soup ladle
cazo sopa
29,7 cm - 11,6 inch



GUEST STAR



Invité d'honneur à la table des chefs, Guest Star séduit les esthètes par la finesse d'une ciselure à l'élégance non dissimulée.

Se dessine ainsi un jeu de matière, où la préciosité du ciselé contraste avec l'éclat du miroir, pour faire de ce couvert un objet de caractère.

An honoured guest at chefs' tables, Guest Star delights aesthetes with the delicacy of a highly elegant "diamond cut".

A variety of materials is presented in which the precious nature of chiselled decoration contrasts with the brilliance of the mirror finish, giving this cutlery character.

Invitado de honor a la mesa de los chefs, Guest Star seduce a los estetas por la finura de una "talla diamante" con una elegancia no disimulada.

Se realza así un juego de materia, donde la preciosidad del cincelado contrasta con el brillo del espejo, para hacer de este cubierto un objeto con carácter.



1. 205525 - FOURCHETTE DE TABLE

table fork
tenedor mesa
20,9 cm - 8,2 inch



12. 177898 - FOURCHETTE DE SERVICE

servicing fork
tenedor de servicio
26 cm - 10,2 inch



2. 177896 - COUTEAU TABLE MONOBLOC LAME SCIE

table knife solid handle serrated
cuchillo mesa hoja sierra
23,2 cm - 9,1 inch



13. 177897 - CUILLER DE SERVICE

servicing spoon
cuchara de servicio
26 cm - 10,2 inch



3. 205526 - CUILLER TABLE

table /pasta spoon
cuchara mesa
20,9 cm - 8,2 inch



14. 183396 - PELLE À TARTE

pastry server
pala de tarta
26,2 cm - 10,3 inch



4. 205531 - CUILLER DESSERT

dessert /soup spoon, oval
cuchara postre
18,4 cm - 7,2 inch



15. 183394 - LOUCHE

soup ladle
cazo sopa
28,5 cm - 11,2 inch



5. 205530 - FOURCHETTE DESSERT

dessert/salad fork
tenedor postre
18,4 cm - 7,2 inch



6. 183397 - COUTEAU DESSERT MONOBLOC LAME UNIE

dessert knife solid handle
cuchillo mesa hoja lisa
20,4 cm - 8,03 inch



7. 205528 - FOURCHETTE POISSON

fish fork
tenedor pescado
18,4 cm - 7,2 inch



8. 205529 - COUTEAU POISSON/GOURMET

fish knife
cuchillo pescado
20,7 cm - 8,2 inch



9. 205527 - CUILLER CAFÉ

coffee tea spoon
cuchara café
14 cm - 5,5 inch



10. 183402 - CUILLER MOKA

demi tasse spoon
cuchara moka
11,1 cm - 4,4 inch



11. 205532 - FOURCHETTE GÂTEAUX/COCKTAIL

pastry/cocktail fork
tenedor pastel/cóctel
14,3 cm - 5,6 inch







SOLSTICE SWING



Couteaux posés sur la tranche
knives placed on its side
cuchillo colocado sobre canto

©Nicolas Broquet's



1. **205559 - FOURCHETTE DE TABLE**
table fork
tenedor mesa
21,3 cm - 8,39 inch 
2. **193776 - COUTEAU TABLE MONOBLOC LAME SCIE**
table knife heavy solid handle serrated
cuchillo mesa monobloc hoja sierra
23,3 cm - 9,17 inch 
3. **205560 - CUILLER TABLE**
table /pasta spoon
cuchara mesa
20,5 cm - 8,07 inch 
4. **205561 - CUILLER À SOUPE ANGLAISE**
bouillon spoon, round
cuchara consomé
18,5 cm - 7,28 inch 
5. **205567 - CUILLER GOURMANDE**
dessert /soup spoon, oval
cuchara postre
18,6 cm - 7,32 inch 
6. **205566 - FOURCHETTE GOURMANDE**
dessert fork
tenedor postre
18,6 cm - 7,32 inch 
7. **181111 - COUTEAU DESSERT MONOBLOC LAME UNIE**
dessert knife heavy solid handle
cuchillo mesa monobloc hoja lisa
20,6 cm - 8,11 inch 
8. **205563 - FOURCHETTE POISSON**
fish fork
tenedor pescado
20 cm - 7,87 inch 
9. **205564 - SPATULE GOURMET**
gourmet spatula
espátula gourmet
20,2 cm - 7,95 inch 
10. **205565 - FOURCHETTE GOURMET**
gourmet fork
tenedor gourmet
20 cm - 7,87 inch 
11. **205562 - CUILLER CAFÉ**
coffee tea spoon
cuchara café
14,3 cm - 5,63 inch 
12. **181109 - CUILLER MOKA**
demi tasse spoon
cuchara moka
11 cm - 4,33 inch 
13. **195647 - CUILLER SODA**
iced tea spoon
cuchara soda
19 cm - 7,48 inch 
14. **181119 - FOURCHETTE MISE EN BOUCHE**
appetizer fork
tenedor caracoles
15,5 cm - 6,1 inch 
15. **181120 - SPATULE MISE EN BOUCHE**
appetizer spatula
espátula aperitivo
15,5 cm - 6,1 inch 
16. **181121 - CUILLER MISE EN BOUCHE**
appetizer fork
tenedor caracoles
11,6 cm - 4,57 inch 
17. **195734 - FOURCHETTE À HUÎTRES**
oyster fork
tenedor ostras
14,1 cm - 5,55 inch 
18. **181112 - TARTINEUR**
butter spreader
espátula mantequilla
16 cm - 6,3 inch 
19. **181114 - FOURCHETTE DE SERVICE**
serving fork
tenedor de servicio
26 cm - 10,24 inch 
20. **181113 - CUILLER DE SERVICE**
serving spoon
cuchara de servicio
26 cm - 10,24 inch 
21. **181122 - SPATULE DE SERVICE**
serving spoon
espátula servicio
25 cm - 9,84 inch 
22. **189999 - SERVICE SALADE**
salad serving set
set servicio/ensalada
30 cm - 11,81 inch 

XY



23. 195767 - LOUCHE
soup ladle
cazo sopa
29,7 cm - 11,69 inch



24. 189998 - CUILLER À SAUCE
sauce ladle
cuchara salsa
18,5 cm - 7,28 inch



©Julie Anstau L'abus d'alcool est dangereux pour la santé, à consommer avec modération. Alcohol is dangerous for your health, drink with moderation. El abuso del alcohol es peligroso para la salud, consumase con moderación.

Cuiller, tartineur, spatule pour présenter mises en bouche et mignardises...
spoon, butter spreader, spatula to present appetizers and delicacies...
cuchara aperitivo, espatulin mantequilla, espatula aperitivo



INTERNATIONAL RANGE



1. 126355 - FOURCHETTE DE TABLE

table fork
tenedor mesa
20,1 cm - 7,9 inch



12. 140852 - CUILLER MOKA

demijohn spoon
cuchara moka
11 cm - 4,33 inch



2. 210731 - COUTEAU TABLE MONOBLOC LAME SCIE

table knife solid handle serrated
cuchillo mesa hoja sierra
23,5 cm - 9,25 inch



new

13. 195740 - CUILLER SODA

iced tea spoon
cuchara soda
19 cm - 7,5 inch



3. 207189 - COUTEAU STEAK MONOBLOC LAME SCIE

steak knife solid handle serrated
cuchillo steak hoja sierra
23,6 cm - 9,29 inch



14. 126383 - FOURCHETTE GÂTEAUX/COCKTAIL

pastry/cocktail fork
tenedor pastel/cóctel
13,7 cm - 5,4 inch



4. 126352 - CUILLER TABLE

table /pasta spoon
cuchara mesa
20,3 cm - 8 inch



15. 195737 - FOURCHETTE À HUÎTRES

oyster fork
tenedor ostras
13,3 cm - 5,24 inch



5. 140855 - CUILLER À SOUPE ANGLAISE

bouillon spoon, round
cuchara consomé
17,9 cm - 7 inch



16. 195747 - COUTEAU À BEURRE MONOBLOC LAME UNIE

butter knife solid handle
espatulín mantequilla hoja lisa
19,4 cm - 7,64 inch



6. 126368 - CUILLER DESSERT

dessert /soup spoon, oval
cuchara postre
17,8 cm - 7 inch



17. 126389 - FOURCHETTE DE SERVICE

service fork
tenedor de servicio
25 cm - 9,84 inch



7. 126371 - FOURCHETTE DESSERT

dessert/salad fork
tenedor postre
17,7 cm - 6,97 inch



18. 126387 - CUILLER DE SERVICE

service spoon
cuchara de servicio
25,4 cm - 10 inch



8. 210732 - COUTEAU DESSERT MONOBLOC LAME UNIE

dessert knife solid handle
cuchillo mesa hoja lisa
20,7 cm - 8,15 inch



new

19. 126391 - SERVICE SALADE

salad serving set
set servicio/ensalada
25,4 cm - 10 inch



9. 126377 - FOURCHETTE POISSON

fish fork
tenedor pescado
17,7 cm - 6,97 inch



20. 126386 - PELLE À TARTE

pastry server
pala de tarta
25,1 cm - 9,88 inch



10. 181181 - COUTEAU POISSON /GOURMET

gourmet/fish knife
cuchillo pescado
20 cm - 7,9 inch



21. 126361 - LOUCHE

soup ladle
cazo sopa
28,8 cm - 11,3 inch



11. 126358 - CUILLER CAFÉ

coffee tea spoon
cuchara café
13,7 cm - 5,4 inch



22. 126393 - CUILLER À SAUCE

sauce ladle
cuchara salsa
15,5 cm - 6,1 inch

























AQUATIC

new



INTERNATIONAL RANGE



1. **105831 - FOURCHETTE DE TABLE**
table fork
tenedor mesa
20,8 cm - 8,2 inch 
2. **182460 - COUTEAU TABLE MONOBLOC LAME SCIE**
table knife solid handle serrated
cuchillo mesa monobloc hoja sierra
24,6 cm - 9,7 inch 
3. **105886 - COUTEAU TABLE MANCHE ORFÈVRE LAME UNIE**
table knife hollow handle
cuchillo mesa enmangado hoja lisa
24,6 cm - 9,7 inch 
4. **105860 - COUTEAU TABLE MANCHE ORFÈVRE LAME SCIE**
table knife hollow handle serrated
cuchillo mesa enmangado hoja sierra
24,6 cm - 9,7 inch 
5. **105801 - COUTEAU STEAK MANCHE ORFÈVRE LAME SCIE**
steak knife hollow handle serrated
cuchillo steak monocasco
23,9 cm - 9,4 inch 
6. **105798 - CUILLER TABLE**
table /pasta spoon
cuchara mesa
20,8 cm - 8,2 inch 
7. **105908 - CUILLER À SOUPE ANGLAISE**
bouillon spoon, round
cuchara consomé
17,4 cm - 6,85 inch 
8. **105861 - CUILLER DESSERT**
dessert /soup spoon, oval
cuchara postre
18 cm - 7,08 inch 
9. **105885 - FOURCHETTE DESSERT**
dessert/salad fork
tenedor postre
17,8 cm - 7,01 inch 
10. **182463 - COUTEAU DESSERT MONOBLOC LAME UNIE**
dessert knife solid handle
cuchillo mesa monobloc hoja lisa
20,5 cm - 8,07 inch 
11. **105832 - COUTEAU DESSERT MANCHE ORFÈVRE LAME UNIE**
dessert knife heavy hollow handle
cuchillo mesa monobloc hoja lisa
20,5 cm - 8,07 inch 
12. **105888 - FOURCHETTE POISSON**
fish fork
tenedor pescado
17,7 cm - 6,97 inch 
13. **105797 - COUTEAU POISSON**
fish knife
cuchillo pescado
19,9 cm - 7,83 inch 
14. **105910 - CUILLER À SAUCE GOURMET**
gourmet sauce spoon, flat
cuchara salsa/gourmet
17,9 cm - 7,05 inch 
15. **105833 - CUILLER CAFÉ**
coffee tea spoon
cuchara café
14 cm - 5,51 inch 
16. **105906 - CUILLER MOKA**
demi tasse spoon
cuchara moka
11 cm - 4,33 inch 
17. **105800 - CUILLER SODA**
iced tea spoon
cuchara soda
18,2 cm - 7,17 inch 
18. **105795 - FOURCHETTE GÂTEAUX/COCKTAIL**
pastry/cocktail fork
tenedor pastel/cóctel
13,8 cm - 5,43 inch 
19. **123440 - FOURCHETTE À HUÎTRES**
oyster fork
tenedor ostras
12,9 cm - 5,08 inch 
20. **132782 - FOURCHETTE À ESCARGOTS**
snail fork
tenedor caracoles
13,5 cm - 5,31 inch 
21. **003332 - COUTEAU À BEURRE MANCHE ORFÈVRE LAME UNIE**
butter knife hollow handle
espatulín mantequilla
18,7 cm - 7,36 inch 
22. **190420 - COUTEAU À BEURRE MONOBLOC LAME UNIE**
butter knife solid handle
espatulín mantequilla
19 cm - 7,48 inch 

23. 003390 - COUTEAU FROMAGE MANCHE ORFÈVRE LAME UNIE

cheese knife hollow handle
cuchillo queso enmangado
19,3 cm - 7,6 inch



24. 130994 - CUILLER TOAST

toast spoon
cuchara aperitivo
11,8 cm - 4,65 inch



25. 002191 - PINCE À SUCRE

sugar tong
pinza para azúcar
11,5 cm - 4,53 inch



26. 002185 - FOURCHETTE DE SERVICE

servicing fork
tenedor de servicio
24,8 cm - 9,76 inch



27. 002186 - CUILLER DE SERVICE

servicing spoon
cuchara de servicio
25 cm - 9,84 inch



28. 040646 - SERVICE SALADE

salad serving set
set servicio/ensalada
25,8 cm - 10,16 inch



29. 083340 - PELLE À TARTE MONOBLOC

pastry server solid handle
pala de tarta
24,9 cm - 9,8 inch



30. 002184 - PELLE À TARTE MANCHE ORFÈVRE

pastry server hollow handle
pala de tarta enmangado
24,4 cm - 9,61 inch



31. 097717 - LOUCHE

soup ladle
cazo sopa
29,8 cm - 11,73 inch























32. 002179 - CUILLER À SAUCE

sauce ladle
cuchara salsa
15,7 cm - 6,18 inch



INTERNATIONAL RANGE



- | | | | |
|--|---|--|---|
| <p>1. 145976 - FOURCHETTE DE TABLE
 <i>table fork</i>
 tenedor mesa
 20,9 cm - 8,2 inch</p> |  | <p>12. 146002 - FOURCHETTE POISSON
 <i>fish fork</i>
 tenedor pescado
 17,9 cm - 7,05 inch</p> |  |
| <p>2. 182472 - COUTEAU TABLE MONOBLOC LAME SCIE
 <i>table knife solid handle serrated</i>
 cuchillo mesa hoja sierra
 24,5 cm - 9,65 inch</p> |  | <p>13. 146005 - COUTEAU POISSON
 <i>fish knife</i>
 cuchillo pescado
 19,7 cm - 7,76 inch</p> |  |
| <p>3. 145984 - COUTEAU TABLE MANCHE ORFÈVRE LAME UNIE
 <i>table knife hollow handle</i>
 cuchillo mesa enmangado hoja lisa
 24,5 cm - 9,65 inch</p> |  | <p>14. 146014 - CUILLER À SAUCE GOURMET
 <i>gourmet sauce spoon, flat</i>
 cuchara salsa/gourmet
 18,1 cm - 7,13 inch</p> |  |
| <p>4. 149065 - COUTEAU TABLE MANCHE ORFÈVRE LAME SCIE
 <i>table knife hollow handle serrated</i>
 cuchillo mesa enmangado hoja sierra
 24,5 cm - 9,65 inch</p> |  | <p>15. 145979 - CUILLER CAFÉ
 <i>coffee tea spoon</i>
 cuchara café
 14,4 cm - 5,67 inch</p> |  |
| <p>5. 154583 - COUTEAU STEAK MANCHE ORFÈVRE LAME SCIE
 <i>steak knife hollow handle serrated</i>
 cuchillo steak monocasco
 24,5 cm - 9,65 inch</p> |  | <p>16. 146030 - CUILLER MOKA
 <i>demi tasse spoon</i>
 cuchara moka
 11 cm - 4,3 inch</p> |  |
| <p>6. 145973 - CUILLER TABLE
 <i>table /pasta spoon</i>
 cuchara mesa
 21,1 cm - 8,33 inch</p> |  | <p>17. 195741 - CUILLER SODA
 <i>iced tea spoon</i>
 cuchara soda
 19 cm - 7,48 inch</p> |  |
| <p>7. 146017 - CUILLER À SOUPE ANGLAISE
 <i>bouillon spoon, round</i>
 cuchara consomé
 17,6 cm - 6,93 inch</p> |  | <p>18. 145990 - FOURCHETTE GÂTEAUX/COCKTAIL
 <i>pastry/cocktail fork</i>
 tenedor pastel/cóctel
 14,2 cm - 5,59 inch</p> |  |
| <p>8. 146008 - CUILLER DESSERT
 <i>dessert /soup spoon, oval</i>
 cuchara postre
 18,1 cm - 7,13 inch</p> |  | <p>19. 195738 - FOURCHETTE À HUITRES
 <i>oyster fork</i>
 tenedor ostras
 13,3 cm - 5,24 inch</p> |  |
| <p>9. 146011 - FOURCHETTE DESSERT
 <i>dessert/salad fork</i>
 tenedor postre
 17,9 cm - 7,05 inch</p> |  | <p>20. 186268 - COUTEAU À BEURRE MANCHE ORFÈVRE LAME UNIE
 <i>butter knife hollow handle</i>
 espatulín mantequilla
 19,5 cm - 7,68 inch</p> |  |
| <p>10. 182473 - COUTEAU DESSERT MONOBLOC LAME UNIE
 <i>dessert knife solid handle</i>
 cuchillo mesa hoja lisa
 21,5 cm - 8,46 inch</p> |  | <p>21. 195746 - COUTEAU À BEURRE MONOBLOC LAME UNIE
 <i>butter knife solid handle</i>
 espatulín mantequilla
 18,9 cm - 7,4 inch</p> |  |
| <p>11. 145996 - COUTEAU DESSERT MANCHE ORFÈVRE LAME UNIE
 <i>dessert knife heavy hollow handle</i>
 cuchillo mesa monobloc hoja lisa
 21,5 cm - 8,46 inch</p> |  | <p>22. 146022 - FOURCHETTE DE SERVICE
 <i>servicing fork</i>
 tenedor de servicio
 27,2 cm - 10,7 inch</p> |  |

23. 146021 - CUILLER DE SERVICE

servicing spoon
cuchara de servicio
27,4 cm - 10,8 inch



24. 146025 - SERVICE SALADE

salad serving set
set servicio/ensalada
30 cm - 11,8 inch



25. 145993 - PELLE À TARTE

pastry server solid handle
pala de tarta
26,3 cm - 10,35 inch



26. 145981 - LOUCHE

soup ladle
cazo sopa
30 cm - 11,8 inch



27. 146027 - CUILLER À SAUCE

sauce ladle
cuchara salsa
15,9 cm - 6,26 inch



©Julie Ansiau

INTERNATIONAL RANGE



1. 105021 - FOURCHETTE DE TABLE

table fork
tenedor mesa
20,9 cm - 8,23 inch



12. 104994 - FOURCHETTE POISSON

fish fork
tenedor pescado
17,9 cm - 7,05 inch



2. 190415 - COUTEAU TABLE LAME SCIE

table knife solid handle serrated
cuchillo mesa hoja sierra
24,8 cm - 9,76 inch



13. 104995 - COUTEAU POISSON

fish knife
cuchillo pescado
20 cm - 7,87 inch



3. 105020 - COUTEAU TABLE MANCHE ORFÈVRE LAME UNIE

table knife hollow handle
cuchillo mesa emmangado hoja lisa
24,8 cm - 9,76 inch



14. 104977 - CUILLER À SAUCE GOURMET

gourmet sauce spoon, flat
cuchara salsa/gourmet
18 cm - 7,08 inch



4. 105006 - COUTEAU TABLE MANCHE ORFÈVRE LAME SCIE

table knife hollow handle serrated
cuchillo mesa emmangado hoja sierra
24,7 cm - 9,72 inch



15. 104986 - CUILLER CAFÉ

coffee tea spoon
cuchara café
14,1 cm - 5,5 inch



5. 122746 - COUTEAU STEAK MANCHE ORFÈVRE LAME SCIE

steak knife hollow handle serrated
cuchillo steak monocasco
23,8 cm - 9,37 inch



16. 104993 - CUILLER MOKA

demi tasse spoon
cuchara moka
11,2 cm - 4,4 inch



6. 104988 - CUILLER TABLE

table /pasta spoon
cuchara mesa
21,1 cm - 8,31 inch



17. 187462 - CUILLER SODA

iced tea spoon
cuchara soda
18,1 cm - 7,13 inch



7. 104975 - CUILLER À SOUPE ANGLAISE

bouillon spoon, round
cuchara consomé
17,4 cm - 6,85 inch



18. 105012 - FOURCHETTE GÂTEAUX/COCKTAIL

pastry/cocktail fork
tenedor pastel/cóctel
13,9 cm - 5,47 inch



8. 104985 - CUILLER DESSERT

dessert /soup spoon, oval
cuchara postre
18 cm - 7,1 inch



19. 105005 - FOURCHETTE À HÛÎTRES

oyster fork
tenedor ostras
13 cm - 5,1 inch



9. 105013 - FOURCHETTE DESSERT

dessert/salad fork
tenedor postre
17,9 cm - 7,05 inch



20. 016394 - COUTEAU À BEURRE MANCHE ORFÈVRE LAME UNIE

butter knife hollow handle
espatulín mantequilla hoja lisa
18,9 cm - 7,44 inch



10. 190416 - COUTEAU DESSERT MONOBLOC LAME UNIE

dessert knife solid handle
cuchillo mesa hoja lisa
21,3 cm - 8,39 inch



21. 190414 - COUTEAU À BEURRE LOURD

butter knife solid handle
espatulín mantequilla
19,7 cm - 7,76 inch



11. 104989 - COUTEAU DESSERT MANCHE ORFÈVRE LAME UNIE

dessert knife heavy hollow handle
cuchillo mesa monobloc hoja lisa
20,6 cm - 8,11 inch



22. 183153 - TARTINEUR

butter spreader
espatulín mantequilla
17,9 cm - 7,05 inch



23. 001288 - FOURCHETTE DE SERVICE

servicing fork
 tenedor de servicio
24,8 cm - 9,76 inch



24. 001289 - CUILLER DE SERVICE

servicing spoon
 cuchara de servicio
24,9 cm - 9,8 inch



25. 050207 - SERVICE SALADE

salad serving set
 set servicio/ensalada
25,7 cm - 10,1 inch



26. 000611 - PELLE À TARTE

pastry server
 pala de tarta
24,8 cm - 9,76 inch



27. 097725 - LOUCHE

soup ladle
 cazo sopa
30,2 cm - 11,9 inch



28. 000610 - CUILLER À SAUCE

sauce ladle
 cuchara salsa
17,1 cm - 6,73 inch



INTERNATIONAL RANGE



1. **163598 - FOURCHETTE DE TABLE**

table fork
tenedor mesa
20,2 cm - 7,95 inch



12. **195646 - CUILLER SODA**

iced tea spoon
cuchara soda
19 cm - 7,48 inch



2. **111970 - COUTEAU TABLE LAME SCIE**

table knife solid handle serrated
cuchillo mesa hoja sierra
23 cm - 9 inch



13. **198495 - CUILLER À GLACE**

iced tea spoon
cuchara para helado
18,9 cm - 7,44 inch



3. **163597 - CUILLER TABLE**

table /pasta spoon
cuchara mesa
20,4 cm - 8 inch



14. **111996 - FOURCHETTE GÂTEAUX/COCKTAIL**

pastry/cocktail fork
tenedor pastel/cóctel
14,5 cm - 5,71 inch



4. **197504 - CUILLER À SOUPE ANGLAISE**

bouillon spoon, round
cuchara consomé
18,5 cm - 7,28 inch



15. **195735 - FOURCHETTE À HÛÎTRES**

oyster fork
tenedor ostras
14,1 cm - 5,6 inch



5. **163602 - CUILLER DESSERT**

dessert /soup spoon, oval
cuchara postre
18,4 cm - 7,24 inch



16. **181112 - TARTINEUR**

butter spreader
espatulín mantequilla
16 cm - 6,3 inch



6. **163603 - FOURCHETTE DESSERT**

dessert/salad fork
tenedor postre
18,5 cm - 7,28 inch



7. **111976 - COUTEAU DESSERT LAME SCIE**

dessert knife solid handle serrated
cuchillo mesa hoja sierra
20,4 cm - 8,03 inch



8. **163600 - FOURCHETTE POISSON**

fish fork
tenedor pescado
18,5 cm - 7,28 inch



9. **163601 - COUTEAU POISSON**

fish knife
cuchillo pescado
20,4 cm - 8,03 inch



10. **163599 - CUILLER CAFÉ**

coffee tea spoon
cuchara café
14,1 cm - 5,5 inch



11. **163604 - CUILLER MOKA**

demi tasse spoon
cuchara moka
12,4 cm - 4,88 inch



OVATION



1. 205540 - FOURCHETTE DE TABLE

table fork
tenedor mesa
20,9 cm - 8,2 inch



2. 159484 - COUTEAU TABLE MONOBLOC LAME SCIE

table knife solid handle serrated
cuchillo mesa hoja sierra
23,2 cm - 9,1 inch



3. 208624 - COUTEAU TABLE MONOBLOC LAME SCIE

table knife solid handle serrated
cuchillo mesa hoja sierra
23 cm - 9,06 inch



new

4. 195763 - COUTEAU STEAK MONOBLOC LAME SCIE

steak knife solid handle serrated
cuchillo steak hoja sierra
23,5 cm - 9,3 inch



5. 205541 - CUILLER TABLE

table /pasta spoon
cuchara mesa
20,9 cm - 8,2 inch



6. 205542 - CUILLER À SOUPE ANGLAISE

bouillon spoon, round
cuchara consommé
17,8 cm - 7 inch



7. 205547 - CUILLER DESSERT

dessert /soup spoon, oval
cuchara postre
18,4 cm - 7,2 inch



8. 205546 - FOURCHETTE DESSERT

dessert/salad fork
tenedor postre
18,4 cm - 7,2 inch



9. 159492 - COUTEAU DESSERT MONOBLOC LAME UNIE

dessert knife solid handle
cuchillo mesa hoja lisa
20,4 cm - 8,03 inch



10. 208625 - COUTEAU DESSERT MONOBLOC LAME SCIE

dessert knife solid handle serrated
cuchillo mesa hoja sierra
20,7 cm - 8,15 inch



new

11. 205544 - FOURCHETTE POISSON

fish fork
tenedor pescado
18,4 cm - 7,2 inch



12. 205545 - COUTEAU POISSON/GOURMET

fish knife
cuchillo pescado
20,7 cm - 8,2 inch



13. 205543 - CUILLER CAFÉ

coffee tea spoon
cuchara café
14 cm - 5,5 inch



14. 159512 - CUILLER MOKA

demi tasse spoon
cuchara moka
11,1 cm - 4,4 inch



15. 195648 - CUILLER SODA

iced tea spoon
cuchara soda
19 cm - 7,48 inch



16. 198493 - CUILLER À GLACE

ice spoon
cuchara helado
18,9 cm - 7,44 inch



17. 205548 - FOURCHETTE GÂTEAUX/COCKTAIL

pastry/cocktail fork
tenedor pastel/cóctel
14,3 cm - 5,6 inch



18. 195733 - FOURCHETTE À HÛÎTRES

oyster fork
tenedor ostras
14,1 cm - 5,6 inch



19. 154612 - COUTEAU À BEURRE MONOBLOC LAME UNIE

butter knife solid handle
espatulín mantequilla hoja lisa
19,4 cm - 7,6 inch



20. 159501 - FOURCHETTE DE SERVICE

servicing fork
tenedor de servicio
26 cm - 10,2 inch



21. 159500 - CUILLER DE SERVICE

servicing spoon
cuchara de servicio
26 cm - 10,2 inch



22. 159504 - SERVICE SALADE

salad serving set
set servicio/ensalada
30 cm - 11,8 inch

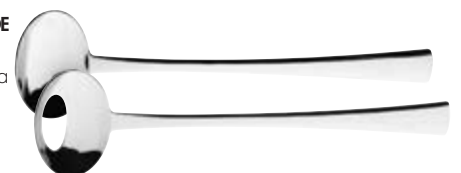

SOLSTICE



23. 159490 - PELLE À TARTE
pastry server
pala de tarta
26,2 cm - 10,3 inch



24. 159482 - LOUCHE
soup ladle
cazo sopa
28,5 cm - 11,2 inch



25. 190013 - CUILLER À SAUCE
sauce ladle
cuchara salsa
18,5 cm - 7,28 inch



new



INTERNATIONAL RANGE



1. 104485 - FOURCHETTE DE TABLE

table fork
tenedor mesa
20,8 cm - 8,2 inch



12. 104507 - FOURCHETTE POISSON

fish fork
tenedor pescado
17,7 cm - 6,97 inch



2. 182466 - COUTEAU TABLE MONOBLOC LAME SCIE

table knife solid handle serrated
cuchillo mesa monobloc hoja sierra
24,6 cm - 9,7 inch



13. 104508 - COUTEAU POISSON

fish knife
cuchillo pescado
19,9 cm - 7,83 inch



3. 161390 - COUTEAU TABLE MANCHE ORFÈVRE LAME UNIE

table knife hollow handle
cuchillo mesa emmangado hoja lisa
24,6 cm - 9,7 inch



14. 145451 - CUILLER À SAUCE GOURMET

gourmet sauce spoon, flat
cuchara salsa/gourmet
17,9 cm - 7,05 inch



4. 161391 - COUTEAU TABLE MANCHE ORFÈVRE LAME SCIE

table knife hollow handle serrated
cuchillo mesa emmangado hoja sierra
24,6 cm - 9,7 inch



15. 104561 - CUILLER CAFÉ

coffee tea spoon
cuchara café
14 cm - 5,51 inch



5. 122759 - COUTEAU STEAK MANCHE ORFÈVRE LAME SCIE

steak knife hollow handle serrated
cuchillo steak monocasco
23,9 cm - 9,4 inch



16. 161398 - CUILLER MOKA

demi tasse spoon
cuchara moka
11 cm - 4,33 inch



6. 104526 - CUILLER TABLE

table /pasta spoon
cuchara mesa
20,8 cm - 8,2 inch



17. 124259 - CUILLER SODA

iced tea spoon
cuchara soda
18,2 cm - 7,17 inch



7. 104448 - CUILLER À SOUPE ANGLAISE

bouillon spoon, round
cuchara consomé
17,4 cm - 6,85 inch



18. 104480 - FOURCHETTE GÂTEAUX/COCKTAIL

pastry/cocktail fork
tenedor pastel/cóctel
13,8 cm - 5,43 inch



8. 104484 - CUILLER DESSERT

dessert /soup spoon, oval
cuchara postre
18 cm - 7,08 inch



19. 104463 - FOURCHETTE À HÛÎTRES

oyster fork
tenedor ostras
13 cm - 5,12 inch



9. 104543 - FOURCHETTE DESSERT

dessert/salad fork
tenedor postre
17,8 cm - 7,01 inch



20. 122760 - COUTEAU À BEURRE MANCHE ORFÈVRE LAME UNIE

butter knife hollow handle
espatulín mantequilla hoja lisa
18,7 cm - 7,36 inch



10. 182467 - COUTEAU DESSERT MONOBLOC LAME UNIE

dessert knife solid handle
cuchillo mesa monobloc hoja lisa
20,5 cm - 8,07 inch



21. 190419 - COUTEAU À BEURRE MONOBLOC LAME UNIE

butter knife solid handle
espatulín mantequilla
18,7 cm - 7,36 inch



11. 161394 - COUTEAU DESSERT MANCHE ORFÈVRE LAME UNIE

dessert knife heavy hollow handle
cuchillo mesa monobloc hoja lisa
20,5 cm - 8,07 inch



22. 161400 - TARTINEUR

butter spreader
espatulín mantequilla
18 cm - 7,08 inch



23. 189208- COUTEAU FROMAGE MANCHE ORFÈVRE

cheese knife hollow handle
cuchillo queso enmangado
19,3 cm - 7,6 inch



24. 195757 - FOURCHETTE DE SERVICE

serving fork
tenedor de servicio
24,8 cm - 9,76 inch



25. 195755 - CUILLER DE SERVICE

serving spoon
cuchara de servicio
25 cm - 9,84 inch



26. 195750 - SERVICE SALADE

salad serving set
set servicio/ensalada
25,7 cm - 10,2 inch



27. 189510 - FOURCHETTE À DÉCOUPER

carving fork
tenedor trinchante
25,4 cm - 10 inch



28. 189511 - COUTEAU À DÉCOUPER MANCHE ORFÈVRE

carving knife hollow handle
tenedor trinchante enmangado
28,7 cm - 11,3 inch



29. 195753 - PELLE À TARTE

pastry server
pala de tarta
24,9 cm - 9,8 inch



30. 195762 - LOUCHE

soup ladle
cazo sopa
29,8 cm - 11,73 inch



31. 195759 - CUILLER À SAUCE

sauce ladle
cuchara salsa
15,7 cm - 6,18 inch



1. 197507 - FOURCHETTE DE TABLE

table fork
tenedor mesa
21,3 cm - 8,39 inch



2. 197509 - COUTEAU TABLE LAME SCIE

table knife serrated
cuchillo mesa hoja sierra
23,2 cm - 9,13 inch



3. 197521 - COUTEAU STEAK LAME SCIE

steak knife serrated
cuchillo steak
23,2 cm - 9,13 inch



4. 197506 - CUILLER TABLE

table /pasta spoon
cuchara mesa
21,6 cm - 8,5 inch



5. 197518 - CUILLER À SOUPE ANGLAISE

bouillon spoon, round
cuchara consomé
18,5 cm - 7,3 inch



6. 197512 - CUILLER DESSERT

dessert /soup spoon, oval
cuchara postre
19,5 cm - 7,68 inch



7. 197511 - FOURCHETTE DESSERT

dessert/salad fork
tenedor postre
19,2 cm - 7,56 inch



8. 210629 - COUTEAU DESSERT MONOBLOC LAME SCIE

dessert knife hollow handle serrated
cuchillo mesa hoja sierra
20,9 cm - 8,23 inch

new



9. 197514 - FOURCHETTE POISSON

fish fork
tenedor pescado
19,2 cm - 7,56 inch



10. 197515 - COUTEAU POISSON/GOURMET

gourmet/fish knife
cuchillo pescado
21,3 cm - 8,39 inch



11. 197508 - CUILLER CAFÉ

coffee tea spoon
cuchara café
14,3 cm - 5,63 inch



12. 197510 - CUILLER MOKA

demi tasse spoon
cuchara moka
11,7 cm - 4,61 inch



13. 197519 - CUILLER SODA

iced tea spoon
cuchara soda
18,9 cm - 7,44 inch



14. 198498 - CUILLER À GLACE

iced spoon
cuchara helado
18,9 cm - 7,44 inch



15. 197516 - FOURCHETTE GÂTEAUX/COCKTAIL

pastry/cocktail fork
tenedor pastel/cóctel
13,9 cm - 5,47 inch



16. 197517 - FOURCHETTE À HÛÎTRES

oyster fork
tenedor ostras
14,1 cm - 5,5 inch



17. 197520 - COUTEAU À BEURRE MONOBLOC LAME UNIE

butter knife solid handle
espatulín mantequilla
19,3 cm - 7,6 inch



18. 197522 - FOURCHETTE DE SERVICE

servicing fork
tenedor de servicio
26,6 cm - 10,47 inch



19. 197523 - CUILLER DE SERVICE

servicing spoon
cuchara de servicio
27 cm - 10,6 inch



20. 197525 - SERVICE SALADE

salad serving set
set servicio/ensalada
30 cm - 11,81 inch



21. 197527 - PELLE À TARTE

pastry server
pala de tarta
25,1 cm - 9,9 inch



22. 197524 - LOUCHE

soup ladle
cazo sopa
29,7 cm - 11,7 inch



GUEST

23. 197526 - CUILLER À SAUCE
sauce ladle
cuchara salsa
17 cm - 6,69 inch



INTERNATIONAL RANGE



1. 153998 - FOURCHETTE DE TABLE

table fork
tenedor mesa
20,7 cm - 8,1 inch



2. 154002 - COUTEAU TABLE LAME SCIE

table knife serrated
cuchillo mesa hoja sierra
23,5 cm - 9,25 inch



3. 199761 - COUTEAU STEAK MONOBLOC LAME SCIE

steak knife solid handle serrated
cuchillo steak hoja sierra
22,8 cm - 8,98 inch



4. 153996 - CUILLER TABLE

table /pasta spoon
cuchara mesa
20,7 cm - 8,15 inch



5. 190015 - CUILLER À SOUPE ANGLAISE

bouillon spoon, round
cuchara consomé
18,3 cm - 7,2 inch



6. 154571 - CUILLER DESSERT

dessert /soup spoon, oval
cuchara postre
18,6 cm - 7,32 inch



7. 154574 - FOURCHETTE DESSERT

dessert/salad fork
tenedor postre
18,6 cm - 7,32 inch



8. 154555 - COUTEAU DESSERT MONOBLOC LAME SCIE

dessert knife heavy solid handle serrated
cuchillo mesa monobloc hoja sierra
21,1 cm - 8,31 inch



new

9. 154558 - FOURCHETTE POISSON

fish fork
tenedor pescado
18,7 cm - 7,36 inch



10. 154561 - COUTEAU POISSON

fish knife
cuchillo pescado
21,1 cm - 8,31 inch



11. 154001 - CUILLER CAFÉ

coffee tea spoon
cuchara café
14,1 cm - 5,5 inch



12. 154577 - CUILLER MOKA

demi tasse spoon
cuchara moka
11,1 cm - 4,37 inch



13. 190016 - CUILLER SODA

iced tea spoon
cuchara soda
19 cm - 7,48 inch



14. 154547 - FOURCHETTE GÂTEAUX/COCKTAIL

pastry/cocktail fork
tenedor pastel/cóctel
14 cm - 5,51 inch



15. 190017 - FOURCHETTE À HÛÎTRES

oyster fork
tenedor ostras
14,1 cm - 5,5 inch



16. 154580 - COUTEAU À BEURRE MONOBLOC LAME UNIE

butter knife solid handle
espatulín mantequilla
19,4 cm - 7,64 inch



17. 154563 - FOURCHETTE DE SERVICE

servicing fork
tenedor de servicio
25,1 cm - 9,9 inch



18. 154562 - CUILLER DE SERVICE

servicing spoon
cuchara de servicio
25,5 cm - 10,04 inch



19. 154566 - SERVICE SALADE

salad serving set
set servicio/ensalada
24,3 cm - 9,5 inch



20. 154552 - PELLE À TARTE

pastry server
pala de tarta
25,3 cm - 9,9 inch



21. 154550 - LOUCHE

soup ladle
cazo sopa
29,7 cm - 11,69 inch



22. 154568 - CUILLER À SAUCE

sauce ladle
cuchara salsa
18,5 cm - 7,28 inch



ASTRÉE CISELÉ



©Julie Ansiau

INTERNATIONAL RANGE

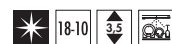

1. 153188 - FOURCHETTE DE TABLE

table fork
tenedor mesa
20,7 cm - 8,1 inch



2. 153196 - COUTEAU TABLE LAME SCIE

table knife serrated
cuchillo mesa hoja sierra
23,5 cm - 9,25 inch



3. 166583 - COUTEAU STEAK

steak knife
cuchillo steak
23,4 cm - 9,2 inch



4. 153185 - CUILLER TABLE

table /pasta spoon
cuchara mesa
20,7 cm - 8,15 inch



5. 184758 - CUILLER À SOUPE ANGLAISE

bouillon spoon, round
cuchara consomé
18,3 cm - 7,2 inch



6. 153209 - CUILLER DESSERT

dessert /soup spoon, oval
cuchara postre
18,6 cm - 7,32 inch



7. 153212 - FOURCHETTE DESSERT

dessert/salad fork
tenedor postre
18,6 cm - 7,32 inch



8. 153200 - COUTEAU DESSERT LAME SCIE

dessert knife solid handle serrated
cuchillo mesa hoja sierra
21,1 cm - 8,31 inch



new

9. 153203 - FOURCHETTE POISSON

fish fork
tenedor pescado
18,6 cm - 7,32 inch



10. 153206 - COUTEAU POISSON

fish knife
cuchillo pescado
21,1 cm - 8,31 inch



11. 153191 - CUILLER CAFÉ

coffee tea spoon
cuchara café
14,1 cm - 5,5 inch



12. 154609 - CUILLER MOKA

demi tasse spoon
cuchara moka
11,1 cm - 4,37 inch



13. 195649 - CUILLER SODA

iced tea spoon
cuchara soda
19 cm - 7,48 inch



14. 198496 - CUILLER À GLACE

iced tea spoon
cuchara soda
18,9 cm - 7,44 inch



15. 154597 - FOURCHETTE GÂTEAUX/COCKTAIL

pastry/cocktail fork
tenedor pastel/cóctel
14 cm - 5,51 inch



16. 195732 - FOURCHETTE À HÛÎTRES

oyster fork
tenedor ostras
14,1 cm - 5,5 inch



17. 162730 - CURETTE À CRUSTACÉS

seafood scraper
rasqueta para cangrejo
19 cm - 7,5 inch



18. 162728 - FOURCHETTE À ESCARGOTS/COCKTAILS

pastry/snail fork
tenedor caracoles/cocktail
10,8 cm - 4,2 inch



19. 154612 - COUTEAU À BEURRE MONOBLOC LAME UNIE

butter knife solid handle
espatulín mantequilla
19,4 cm - 7,64 inch



20. 154601 - FOURCHETTE DE SERVICE

servicing fork
tenedor de servicio
25,1 cm - 9,9 inch



21. 154600 - CUILLER DE SERVICE

servicing spoon
cuchara de servicio
25,5 cm - 10,04 inch



22. 154604 - SERVICE SALADE

salad serving set
set servicio/ensalá
24,3 cm - 9,5 inch



ASTRÉE

23. 154599 - PELLE À TARTE

pastry server
pala de tarta
25,3 cm - 9,9 inch



24. 195765 - LOUCHE

soup ladle
cazo sopa
29,7 cm - 11,69 inch



25. 195766 - CUILLER À SAUCE

sauce ladle
cuchara salsa
18,5 cm - 7,28 inch



INTERNATIONAL RANGE



1. **163580 - FOURCHETTE DE TABLE**
table fork
tenedor mesa
20,9 cm - 8,23 inch 
2. **189969 - COUTEAU TABLE LAME SCIE**
table knife serrated
cuchillo mesa hoja sierra
22,9 cm - 9 inch 
3. **207189 - COUTEAU STEAK**
steak knife
cuchillo steak
23,6 cm - 9,29 inch 
4. **163579 - CUILLER TABLE**
table /pasta spoon
cuchara mesa
21,1 cm - 8,31 inch 
5. **189967 - CUILLER À SOUPE ANGLAISE**
bouillon spoon, round
cuchara consomé
17,8 cm - 7,01 inch 
6. **164713 - CUILLER DESSERT**
dessert /soup spoon, oval
cuchara postre
19 cm - 7,48 inch 
7. **164714 - FOURCHETTE DESSERT**
dessert/salad fork
tenedor postre
18,9 cm - 7,44 inch 
8. **210627 - COUTEAU DESSERT LAME SCIE**
dessert knife solid handle serrated
cuchillo mesa hoja sierra
20,6 cm - 8,11 inch  **new**
9. **164708 - FOURCHETTE POISSON**
fish fork
tenedor pescado
18,9 cm - 7,44 inch 
10. **164709 - COUTEAU POISSON/GOURMET**
gourmet/fish knife
cuchillo pescado
21 cm - 8,27 inch 
11. **163581 - CUILLER CAFÉ**
coffee tea spoon
cuchara café
14,3 cm - 5,63 inch 
12. **164715 - CUILLER MOKA/TOUILLETTE**
demi tasse spoon
cuchara moka
11 cm - 4,33 inch 
13. **195742 - CUILLER SODA**
iced tea spoon
cuchara soda
19 cm - 7,48 inch 
14. **164705 - FOURCHETTE GÂTEAUX/COCKTAIL**
pastry/cocktail fork
tenedor pastel/cóctel
14,4 cm - 5,67 inch 
15. **195739 - FOURCHETTE À HÛÎTRES**
oyster fork
tenedor ostras
13,3 cm - 5,24 inch 
16. **162728 - FOURCHETTE À ESCARGOTS/COCKTAILS**
pastry/snail fork
tenedor caracoles/cocktail
10,8 cm - 4,2 inch 
17. **162730 - CURETTE À CRUSTACÉS**
seafood scraper
rasqueta para cangrejo
19 cm - 7,5 inch 
18. **195745 - COUTEAU À BEURRE MONOBLOC LAME UNIE**
butter knife solid handle
espatulín mantequilla
18,9 cm - 7,44 inch 
19. **163586 - FOURCHETTE DE SERVICE**
serving fork
tenedor de servicio
27,1 cm - 10,67 inch 
20. **163585 - CUILLER DE SERVICE**
serving spoon
cuchara de servicio
27,3 cm - 10,75 inch 
21. **164710 - SERVICE SALADE**
salad serving set
set servicio/ensalada
27,3 cm - 10,3 inch 
22. **164706 - PELLE À TARTE**
pastry server
pala de tarta
25,4 cm - 10 inch 

ALO A



23. 163582 - LOUCHE
soup ladle
cazo sopa
29 cm - 11,42 inch



24. 189968 - CUILLER À SAUCE
sauce ladle
cuchara salsa
16,5 cm - 6,5 inch



INTERNATIONAL RANGE



1. 111894 - FOURCHETTE DE TABLE

table fork
tenedor mesa
20,4 cm - 8,03 inch



2. 111921 - COUTEAU TABLE MONOBLOC LAME SCIE

table knife solid handle serrated
cuchillo mesa hoja sierra
23 cm - 9,06 inch



3. 111891 - CUILLER TABLE

table /pasta spoon
cuchara mesa
20,4 cm - 8,03 inch



4. 120967 - CUILLER À SOUPE ANGLAISE

bouillon spoon, round
cuchara consomé
18 cm - 7,09 inch



5. 111904 - CUILLER DESSERT

dessert /soup spoon, oval
cuchara postre
18 cm - 7,09 inch



6. 111907 - FOURCHETTE DESSERT

dessert/salad fork
tenedor postre
18 cm - 7,09 inch



7. 210631 - COUTEAU DESSERT LAME SCIE

dessert knife solid handle serrated
cuchillo mesa hoja sierra
20,3 cm - 7,99 inch



new

8. 111910 - FOURCHETTE POISSON

fish fork
tenedor pescado
17,9 cm - 7,05 inch



9. 111913 - COUTEAU POISSON

fish knife
cuchillo pescado
19,7 cm - 7,76 inch



10. 111916 - FOURCHETTE GÂTEAUX/COCKTAIL

pastry/cocktail fork
tenedor pastel/cóctel
15 cm - 5,91 inch



11. 111897 - CUILLER CAFÉ

coffee tea spoon
cuchara café
13,6 cm - 5,35 inch



12. 114437 - CUILLER MOKA

demi tasse spoon
cuchara moka
11 cm - 4,33 inch



13. 114435 - FOURCHETTE DE SERVICE

serving fork
tenedor de servicio
25,5 cm - 10,04 inch



14. 114434 - CUILLER DE SERVICE

serving spoon
cuchara de servicio
25,5 cm - 10,04 inch



15. 114433 - SERVICE SALADE

salad serving set
set servicio/ensalada
25,6 cm - 10,08 inch



16. 111918 - PELLE À TARTE

pastry server
pala de tarta
25,1 cm - 9,9 inch



17. 111899 - LOUCHE

soup ladle
cazo sopa
30,5 cm - 12,01 inch



18. 118040 - CUILLER À SAUCE

sauce ladle
cuchara salsa
15,8 cm - 6,22 inch



1. 193141 - FOURCHETTE DE TABLE

table fork
tenedor mesa
20,7 cm - 8,15 inch



2. 193162 - COUTEAU TABLE/STEAK LAME SCIE

table/steak knife serrated
cuchillo mesa/steak hoja sierra
22,4 cm - 8,82 inch



3. 193140 - CUILLER TABLE

table /pasta spoon
cuchara mesa
20,9 cm - 8,23 inch



4. 193145 - CUILLER DESSERT /GLACE

dessert /ice spoon
cuchara postre/helado
18,8 cm - 7,4 inch



5. 193144 - FOURCHETTE DESSERT/ POISSON

dessert/fish fork
tenedor postre/pescado
18,8 cm - 7,4 inch



6. 210632 - COUTEAU DESSERT MONOBLOC LAME SCIE

dessert knife solid handle serrated
cuchillo mesa hoja sierra
20,1 cm - 7,91 inch

new



7. 193146 - COUTEAU POISSON/GOURMET

gourmet/fish knife
cuchillo pescado gourmet
20,9 cm - 8,23 inch



8. 193435 - CUILLER CAFÉ

coffee tea spoon
cuchara café
14,2 cm - 5,59 inch



9. 1993142 - CUILLER MOKA/VERRINE

demi tasse/appetizer spoon
cuchara moka/vaso coctel
12 cm - 4,72 inch



10. 198497 - CUILLER À GLACE

ice spoon
cuchara helado
18,9 cm - 7,44 inch



SILLAGES



1. 141089 - FOURCHETTE DE TABLE

table fork
tenedor mesa
20,3 cm - 7,99 inch



2. 113017 - COUTEAU TABLE MONOBLOC LAME SCIE

table knife solid handle serrated
cuchillo mesa hoja sierra
24,4 cm - 9,61 inch



3. 160427 - COUTEAU STEAK MONOBLOC LAME SCIE

steak knife solid handle serrated
cuchillo steak hoja sierra
23,2 cm - 9,13 inch



4. 141086 - CUILLER TABLE

table /pasta spoon
cuchara mesa
20,4 cm - 8,03 inch



5. 112695 - CUILLER À SOUPE ANGLAISE

bouillon spoon, round
cuchara consomé
17,2 cm - 6,77 inch



6. 108236 - CUILLER DESSERT

dessert /soup spoon, oval
cuchara postre
17,9 cm - 7,05 inch



7. 108238 - FOURCHETTE DESSERT

dessert/salad fork
tenedor postre
17,8 cm - 7,01 inch



8. 113019 - COUTEAU DESSERT MONOBLOC LAME UNIE

dessert knife solid handle
cuchillo mesa monobloc hoja lisa
21 cm - 8,27 inch



9. 108922 - FOURCHETTE POISSON

fish fork
tenedor pescado
17,8 cm - 7,01 inch



10. 108924 - COUTEAU POISSON

fish knife
cuchillo pescado
19,7 cm - 7,76 inch



11. 103550 - CUILLER CAFÉ

coffee tea spoon
cuchara café
13,5 cm - 5,31 inch



12. 109465 - CUILLER MOKA

demi tasse spoon
cuchara moka
11 cm - 4,33 inch



13. 123437 - CUILLER SODA

iced tea spoon
cuchara soda
18 cm - 7,09 inch



14. 109466 - FOURCHETTE GÂTEAUX/COCKTAIL

pastry/cocktail fork
tenedor pastel/cóctel
15 cm - 5,91 inch



15. 123434 - FOURCHETTE À HÛÎTRES

oyster fork
tenedor ostras
12,9 cm - 5,08 inch



16. 195744 - COUTEAU À BEURRE MONOBLOC LAME UNIE

butter knife solid handle
espatulín mantequilla
18,9 cm - 7,4 inch



17. 195756 - FOURCHETTE DE SERVICE

servicing fork
tenedor de servicio
24,8 cm - 9,76 inch



18. 195754 - CUILLER DE SERVICE

servicing spoon
cuchara de servicio
24,8 cm - 9,76 inch



19. 195748 - SERVICE SALADE

salad serving set
set servicio/ensalada
26,2 cm - 10,3 inch



20. 195752 - PELLE À TARTE

pastry server
pala de tarta
25,1 cm - 9,9 inch



21. 195761 - LOUCHE

soup ladle
cazo sopa
29,1 cm - 11,46 inch



22. 195760 - CUILLER À SAUCE

sauce ladle
cuchara salsa
15,7 cm - 6,1 inch



MIKADO



INTERNATIONAL RANGE



1. **141094 - FOURCHETTE DE TABLE**
table fork
tenedor mesa
20,3 cm - 7,99 inch 
2. **103857 - COUTEAU TABLE MONOBLOC LAME SCIE**
table knife solid handle serrated
cuchillo mesa hoja sierra
23,7 cm - 9,33 inch 
3. **119459 - COUTEAU TABLE MONOBLOC LOURD LAME SCIE**
table knife solid handle serrated
cuchillo mesa pesado hoja sierra
23,8 cm - 9,37 inch 
4. **160433 - COUTEAU STEAK LAME SCIE**
steak knife serrated
cuchillo steak monocasco
23,6 cm - 9,29 inch 
5. **141092 - CUILLER TABLE**
table /pasta spoon
cuchara mesa
20,4 cm - 8,03 inch 
6. **112692 - CUILLER À SOUPE ANGLAISE**
bouillon spoon, round
cuchara consommé
17,2 cm - 6,77 inch 
7. **108232 - CUILLER DESSERT**
dessert /soup spoon, oval
cuchara postre
17,9 cm - 7,05 inch 
8. **108234 - FOURCHETTE DESSERT**
dessert/salad fork
tenedor postre
17,8 cm - 7,01 inch 
9. **210628 - COUTEAU DESSERT MONOBLOC LAME SCIE** **new**
dessert knife solid handle serrated
cuchillo postre hoja sierra
20,6 cm - 8,11 inch 
10. **119462 - COUTEAU DESSERT MONOBLOC LOURD LAME UNIE**
dessert knife heavy solid handle
cuchillo postre hoja lisa
20,5 cm - 8,07 inch 
11. **108918 - FOURCHETTE POISSON**
fish fork
tenedor pescado
17,8 cm - 7,01 inch 
12. **108920 - COUTEAU POISSON**
fish knife
cuchillo pescado
19,7 cm - 7,76 inch 
13. **103564 - CUILLER CAFÉ**
coffee tea spoon
cuchara café
13,5 cm - 5,31 inch 
14. **109471 - CUILLER MOKA**
demi tasse spoon
cuchara moka
11 cm - 4,33 inch 
15. **123444 - CUILLER SODA**
iced tea spoon
cuchara soda
18 cm - 7,08 inch 
16. **109472 - FOURCHETTE GÂTEAUX/COCKTAIL**
pastry/cocktail fork
tenedor pastel/cóctel
15 cm - 5,91 inch 
17. **123440 - FOURCHETTE À HUITRES**
oyster fork
tenedor ostras
12,9 cm - 5,08 inch 
18. **132782 - FOURCHETTE À ESCARGOTS**
snail fork
tenedor caracoles
13,5 cm - 5,31 inch 
19. **183159 - TARTINEUR**
butter spreader
espatulín mantequilla
18,1 cm - 7,13 inch 
20. **109475 - FOURCHETTE DE SERVICE**
serving fork
tenedor de servicio
24,8 cm - 9,76 inch 
21. **109474 - CUILLER DE SERVICE**
serving spoon
cuchara de servicio
24,8 cm - 9,76 inch 
22. **109470 - SERVICE SALADE**
salad serving set
set servicio/ensalada
24,2 cm - 9,53 inch 

CONFIDENCE

23. 109473 - PELLE À TARTE

pastry server
pala de tarta
25,1 cm - 9,9 inch



24. 103566 - LOUCHE

soup ladle
cazo sopa
35 cm - 13,78 inch



25. 128380 - CUILLER À SAUCE

sauce ladle
cuchara salsa
19 cm - 7,5 inch



INTERNATIONAL RANGE



1. 105804 - FOURCHETTE DE TABLE

table fork
tenedor mesa
21 cm - 8,27 inch



2. 105892 - COUTEAU TABLE LAME SCIE

table knife serrated
cuchillo mesa hoja sierra
25 cm - 9,84 inch



3. 105864 - COUTEAU TABLE MANCHE ORFÈVRE LAME UNIE

table knife hollow handle
cuchillo mesa enmangado hoja lisa
24,7 cm - 9,72 inch



4. 105913 - COUTEAU TABLE MANCHE ORFÈVRE LAME SCIE

table knife hollow handle serrated
cuchillo mesa enmangado hoja sierra
24,7 cm - 9,72 inch



5. 160424 - COUTEAU STEAK MANCHE ORFÈVRE LAME SCIE

steak knife hollow handle serrated
cuchillo steak enmangado hoja sierra
23,2 cm - 9,13 inch



6. 105911 - CUILLER TABLE

table /pasta spoon
cuchara mesa
21 cm - 8,27 inch



7. 105863 - CUILLER DESSERT

dessert /soup spoon, oval
cuchara postre
18 cm - 7,09 inch



8. 105890 - FOURCHETTE DESSERT

dessert/salad fork
tenedor postre
18 cm - 7,09 inch



9. 210626 - COUTEAU DESSERT MONOBLOC LAME SCIE

dessert knife solid handle serrated
cuchillo postre hoja sierra
20,7 cm - 8,15 inch



new

10. 105802 - COUTEAU DESSERT MANCHE ORFÈVRE LAME UNIE

dessert knife hollow handle
cuchillo postre enmangado hoja lisa
20,5 cm - 8,07 inch



11. 105837 - FOURCHETTE POISSON

fish fork
tenedor pescado
18 cm - 7,09 inch



12. 105912 - COUTEAU POISSON

fish knife
cuchillo pescado
20 cm - 7,87 inch



13. 105838 - CUILLER CAFÉ

coffee tea spoon
cuchara café
14,1 cm - 5,5 inch



14. 105891 - CUILLER MOKA

demi tasse spoon
cuchara moka
11 cm - 4,33 inch



15. 105805 - FOURCHETTE GÂTEAUX/COCKTAIL

pastry/cocktail fork
tenedor pastel/cóctel
13,9 cm - 5,47 inch



16. 105803 - FOURCHETTE À HUÎTRES

oyster fork
tenedor ostras
13,2 cm - 5,20 inch



17. 000490 - FOURCHETTE DE SERVICE

servicing fork
tenedor de servicio
24,6 cm - 9,69 inch



18. 000491 - CUILLER DE SERVICE

servicing spoon
cuchara de servicio
24,9 cm - 9,8 inch



19. 000489 - PELLE À TARTE

pastry server
pala de tarta
25,2 cm - 9,92 inch



20. 097741 - LOUCHE

soup ladle
cazo sopa
35,6 cm
14,02 inch



VIEUX PARIS



- 1. 205878 - FOURCHETTE DE TABLE**
table fork
tenedor mesa
21,6 cm - 8,5 inch
- 2. 205880 - COUTEAU TABLE /STEAK**
steak/table knife
cuchillo mesa/steak
23 cm - 9,06 inch
- 3. 205879 - CUILLER TABLE**
table /pasta spoon
cuchara mesa
21,8 cm - 8,58 inch
- 4. 205881 - CUILLER CAFÉ**
coffee tea spoon
cuchara café
15,2 cm - 5,98 inch
- 5. 205873 - FOURCHETTE DE TABLE**
table fork
tenedor mesa
21,6 cm - 8,50 inch
- 6. 205875 - COUTEAU TABLE /STEAK**
steak/table knife
cuchillo mesa/steak
23 cm - 9,06 inch
- 7. 205874 - CUILLER TABLE**
table /pasta spoon
cuchara mesa
21,8 cm - 8,58 inch
- 8. 205876 - CUILLER CAFÉ**
coffee tea spoon
cuchara café
15,2 cm - 5,98 inch
- 9. 205883 - FOURCHETTE DE TABLE**
table fork
tenedor mesa
21,6 cm - 8,50 inch
- 10. 205885 - COUTEAU TABLE /STEAK**
steak/table knife
cuchillo mesa/steak
23 cm - 9,06 inch
- 11. 205884 - CUILLER TABLE**
table /pasta spoon
cuchara mesa
21,8 cm - 8,58 inch
- 12. 205886 - CUILLER CAFÉ**
coffee tea spoon
cuchara café
15,2 cm - 5,98 inch
- 13. 205889 - FOURCHETTE DE TABLE**
table fork
tenedor mesa
21,6 cm - 8,5 inch
- 14. 205891 - COUTEAU TABLE /STEAK**
steak/table knife
cuchillo mesa/steak
23 cm - 9,06 inch
- 15. 205890 - CUILLER TABLE**
table /pasta spoon
cuchara mesa
21,8 cm - 8,58 inch
- 16. 205892 - CUILLER CAFÉ**
coffee tea spoon
cuchara café
15,2 cm - 5,98 inch
- 17. 206782 - FOURCHETTE DE TABLE**
table fork
tenedor mesa
21,6 cm - 8,5 inch
- 18. 205894 - COUTEAU TABLE /STEAK**
steak/table knife
cuchillo mesa/steak
23 cm - 9,06 inch
- 19. 206783 - CUILLER TABLE**
table /pasta spoon
cuchara mesa
21,8 cm - 8,58 inch
- 20. 206784 - CUILLER CAFÉ**
coffee tea spoon
cuchara café
15,2 cm - 5,98 inch

QUARTZ BLEU



QUARTZ AMÉTHISTE

QUARTZ CITRINE



QUARTZ

21. 205868 - FOURCHETTE DE TABLE

table fork
tenedor mesa
21,6 cm - 8,5 inch



QUARTZ TANGERINE

22. 205870 - COUTEAU TABLE /STEAK

steak/table knife
cuchillo mesa/steak
23 cm - 9,06 inch



23. 205869- CUILLER TABLE

table /pasta spoon
cuchara mesa
21,8 cm - 8,58 inch



24. 205871 - CUILLER CAFÉ

coffee tea spoon
cuchara café
15,2 cm - 5,98 inch



©Julie Ansiau

Un couvert aux multiples facettes pour une parfaite prise en main, et une belle gamme de couleurs minérales pour apporter un éclat de lumière à vos tables.

Multi-faceted cutlery which fits perfectly in your hand and a beautiful range of mineral colors to bring a touch of light to your tables.

Un cubierto con múltiples facetas para una perfecta atención y una hermosa gama de colores minerales para aportar un brillo de luz a sus mesas.



PIÈCES COMPLÉMENTAIRES



1. 159451 - COUTEAU TABLE/ STEAK GOURMET

Gourmet table / steak knife
cuchillo mesa/ steak Gourmet
23,5 cm - 9,25 inch



2. 122418 - COUTEAU TABLE/ STEAK GRILLADE

grillade table / steak knife
cuchillo mesa/ steak
22,1 cm - 8,70 inch



3. 162722 - CUILLER MOKA/VERRINE

demi tasse spoon
cuchara moka
10,8 cm - 4,25 inch



4. 169508 - CUILLER SODA

iced tea spoon
cuchara soda/helado
19 cm - 7,48 inch



5. 162726 - FOURCHETTE À HUÎTRES

oyster fork
tenedor ostras
14,7 cm - 5,79 inch



6. 162728 - FOURCHETTE À ESCARGOTS/COCKTAIL

pastry/snail fork
tenedor caracoles/cocktail
10,8 cm - 4,3 inch



7. 162730 - CURETTE À CRUSTACÉS

seafood scraper
rasqueta para cangrejo
19 cm - 7,5 inch



8. 162724 - CUILLER À AGRUMES

citrus spoon
cuchara cítricos
15,3 cm - 6,02 inch



9. 154612 - COUTEAU À BEURRE

butter knife
espatulín mantequilla
19,4 cm - 7,64 inch



PETIT GOURMET

Une nouvelle collection de couverts pour enfants, pour manger comme les grands !

Dessinés pour les petites mains des enfants ces couverts ergonomiques sont réalisés en acier 18-10, et existent également en version métal argenté.

A new collection of flatware for children, to eat like mum and dad !

Drawn for the small hands of the children, this ergonomic flatware is made of 18-10 stainless steel, and also exist in silver plated version.



1. 207256 - CUILLER CAFÉ

coffee tea spoon
cuchara café
13,2 cm - 5,20 inch

2. 207258 - CUILLER DESSERT

dessert /soup spoon, oval
cuchara postre
16,5 cm - 6,5 inch

3. 207257 - FOURCHETTE DESSERT

dessert/salad fork
tenedor postre
16,5 cm - 6,5 inch

4. 207259 - COUTEAU DESSERT

dessert knife solid handle
cuchillo mesa
17,7 cm - 7 inch



1. 207537 - CUILLER CAFÉ

coffee tea spoon
cuchara café

2. 207539 - CUILLER DESSERT

dessert /soup spoon, oval
cuchara postre

3. 207538 - FOURCHETTE DESSERT

dessert/salad fork
tenedor postre

4. 207540 - COUTEAU DESSERT

dessert knife solid handle
cuchillo mesa



GLASSWARE

Created to meet the hospitality professionals requirements, the Degrenne collection of stemmed glasses and tumblers cover a wide choice of designs.

The high quality crystalline glass collection guarantees :

- . a brilliant shine*
- . a sound quality similar to crystal*
- . an exceptional strength to withstand impacts and scratches*
- . an excellent performance in the dishwasher.*

This collection is complemented by a wide range of mass-coloured, hand-blown tumblers.

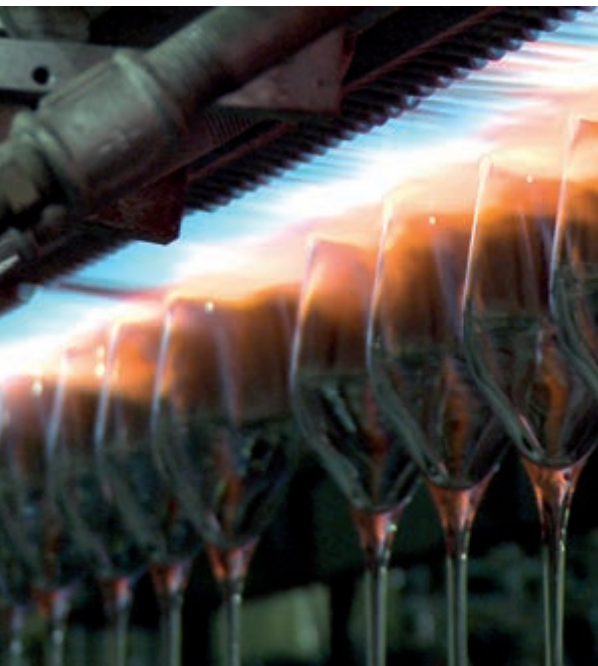

CRISTALERIA

Diseñadas para responder a las exigencias de los profesionales de la restauración y de la hostelería, las colecciones de copas y vasos Degrenne ofrecen una amplia selección de modelos.

La colección de copas de cristalino de alta calidad garantiza :

- . un gran brillo*
- . una sonoridad cercana al cristal*
- . una resistencia excepcional a los golpes y a las rayaduras*
- . una excelente resistencia al lavavajillas.*

Esta colección se completa con una amplia oferta de vasos de vidrio soplado a boca, color, pintados en masa.

LE VERRE

Conçues pour répondre aux exigences des professionnels de la restauration et de l'hôtellerie, les collections de verres à pied et gobelets Degrenne offrent un large choix de modèles.

La collection de verres en cristallin haute qualité garantit :

- . une grande brillance
- . une sonorité proche du cristal
- . une résistance exceptionnelle aux chocs et à la rayure
- . une excellente tenue au lave vaisselle.



Cette collection est complétée par une offre large de gobelets soufflés bouche couleur, teintés masse.

DANDY



- | | |
|--|--|
| <p>1. 184581 VERRE À EAU
 <i>water glass</i>
 copa de agua
 48 cl - 1,6 oz
 Ø 8,9 cm - 3,5 inch
 23,5 cm - 9,3 inch</p> | <p>3. 184583 VERRE À VIN BLANC
 <i>white wine glass</i>
 copa de vino blanco
 35 cl 1 1²/₃ oz
 Ø 8 cm - 3,1 inch
 22,3 cm - 8,8 inch</p> |
| <p>2. 184582 VERRE À VIN ROUGE
 <i>red wine glass</i>
 copa de vino tinto
 42 cl - 1,4 oz
 Ø 8,3 cm - 3,3 inch
 23,1 cm - 9,1 inch</p> | <p>4. 184584 FLÛTE À CHAMPAGNE
 <i>champagne flute</i>
 flauta champagne
 27 cl - 9 oz
 Ø 8 cm - 3,1 inch
 24,3 cm - 9,6 inch</p> |

L'abus d'alcool est dangereux pour la santé, à consommer avec modération.
 Alcohol is dangerous for your health, drink with moderation.
 El abuso del alcohol es peligroso para la salud, consúmase con moderación.

MUSE



- | | | | |
|--|--|--|--|
| <p>1. 184547 VERRE À EAU
 <i>water glass</i>
 copa de agua
 45 cl - 1,5 oz
 Ø 8,4 cm - 3,3 inch
 22,5 cm - 8,9 inch</p> | <p>4. 184551 FLÛTE À CHAMPAGNE
 <i>champagne flute</i>
 flauta champagne
 19 cl - 6¹/₃ oz
 Ø 6,3 cm - 2,5 inch
 22,4 cm - 8,8 inch</p> | <p>7. 184555 GOBELET HAUT
 <i>high tumbler</i>
 vaso alto
 36 cl - 12 oz
 Ø 6,8 cm - 2,7 inch
 14,2 cm - 5,6 inch</p> | <p>10. 184552 GOBELET BAS VERRINE
 <i>low appetizer</i>
 vaso bajo
 15 cl - 5 oz
 Ø 6,4 cm - 2,5 inch
 8 cm - 3,1 inch</p> |
| <p>2. 184548 VERRE À VIN ROUGE
 <i>red wine glass</i>
 copa de vino tinto
 35 cl - 1 1²/₃ oz
 Ø 8 cm - 3,1 inch
 21,4 cm - 8,4 inch</p> | <p>5. 210812 VERRE À BOURGOGNE
 <i>burgundy glass</i>
 copa bourgogne
 70 cl - 23¹/₃ oz
 Ø 10,5 cm - 4 inch
 23,1 cm - 9 inch</p> | <p>8. 184554 GOBELET BAS
 <i>low tumbler</i>
 vaso bajo
 33 cl - 11 oz
 Ø 8 cm - 3,1 inch
 10,2 cm - 4 inch</p> | |
| <p>3. 184549 VERRE À VIN BLANC
 <i>white wine glass</i>
 copa de vino blanco
 28 cl - 9¹/₃ oz
 Ø 7,4 cm - 3 inch
 20,8 cm - 8,2 inch</p> | <p>6. 184550 VERRE À BORDEAUX
 <i>bordeaux glass</i>
 copa bordeaux
 64,5 cl - 21¹/₂ oz
 Ø 9,5 cm - 3,7 inch
 23,8 cm - 9,4 inch</p> | <p>9. 184553 GOBELET BAS
 <i>low tumbler</i>
 vaso bajo
 23 cl - 7²/₃ oz
 Ø 7,6 cm - 3 inch
 9,2 cm - 3,6 inch</p> | |





- | | |
|---|---|
| <p>1. 184561 VERRE À EAU
 <i>water glass</i>
 copa de aqua
 49,5 cl - 1 6^{1/2} oz
 Ø 8,6 cm - 3,4 inch
 22,7 cm - 8,9 inch</p> | <p>4. 184566 FLÛTE À CHAMPAGNE
 <i>champagne flute</i>
 flauta champagne
 19 cl - 6^{1/3} oz
 Ø 5,3 cm - 2 inch
 21,9 cm - 8,6 inch</p> |
| <p>2. 184562 VERRE À VIN ROUGE
 <i>red wine glass</i>
 copa de vino finto
 37 cl - 1 2^{1/3} oz
 Ø 7,7 cm - 3 inch
 21,4 cm - 8,4 inch</p> | <p>5. 184565 VERRE À BOURGOGNE
 <i>burgundy glass</i>
 copa bourgogne
 75 cl - 25 oz
 Ø 10,7 cm - 4,2 inch
 22,5 cm - 8,9 inch</p> |
| <p>3. 184563 VERRE À VIN BLANC
 <i>white wine glass</i>
 copa de vino blanco
 28 cl 9^{1/3} oz
 Ø 7,3 cm - 2,9 inch
 21,2 cm - 8,3 inch</p> | <p>6. 184564 VERRE À BORDEAUX
 <i>bordeaux glass</i>
 copa bordeaux
 65 cl - 2 1^{2/3} oz
 Ø 9,4 cm - 3,7 inch
 23,9 cm - 9,4 inch</p> |



- | | |
|--|---|
| <p>1. 186610 VERRE À EAU
 <i>water glass</i>
 copa de aqua
 49 cl - 1 6^{1/3} oz
 Ø 9 cm - 3,5 inch
 22,5 cm - 8,9 inch</p> | <p>3. 186612 FLÛTE À CHAMPAGNE
 <i>champagne flute</i>
 flauta champagne
 20 cl - 6^{2/3} oz
 Ø 7,5 cm - 3 inch
 22,5 cm - 8,9 inch</p> |
| <p>2. 186611 VERRE À VIN
 <i>wine glass</i>
 copa de vino
 36,5 cl - 1 2^{0,5/3} oz
 Ø 8,2 cm - 3,2 inch
 22 cm - 8,7 inch</p> | <p>4. 186009 VERRE À DÉGUSTATION
 <i>tasting glass</i>
 copa de degustación
 54,5 cl - 1 8^{0,5/3} oz
 Ø 10,7 cm - 4,2 inch
 22 cm - 8,7 inch</p> |



MONTMARTRE



1. **184575 VERRE À EAU**
water glass
copa de agua
42 cl - 14 oz
Ø 8,7 cm - 3,4 inch
20,5 cm - 8,1 inch
2. **184576 VERRE À VIN ROUGE**
red wine glass
copa de vino tinto
32 cl - 10²/₃ oz
Ø 7,8 cm - 3 inch
19,8 cm - 7,8 inch
3. **208481 VERRE À VIN ROUGE AVEC DOUBLE JAUGE 12,5/14 CL**
red wine glass (2 capacity
measurements 4 - 5,5 oz)
copa de vino tinto con indicator
32 cl - 10²/₃ oz
Ø 7,8 cm - 3 inch
19,8 cm - 7,8 inch
4. **184577 VERRE À VIN BLANC**
white wine glass
copa de vino blanco
25 cl 8¹/₃ oz
Ø 7,5 cm - 3 inch
18,4 cm - 7,2 inch
5. **184578 VERRE À VIN**
wine glass
copa de vino
20 cl - 6²/₃ oz
Ø 7 cm - 2,8 inch
17,4 cm - 6,9 inch
6. **184580 FLÛTE À CHAMPAGNE**
champagne flute
flauta champagne
21 cl - 7 oz
Ø 7 cm - 2,8 inch
21 cm - 8,3 inch
7. **184579 VERRE À BOURGOGNE**
burgundy glass
copa bourgogne
58 cl - 19¹/₃ oz
Ø 10 cm - 4 inch
20 cm - 7,9 inch

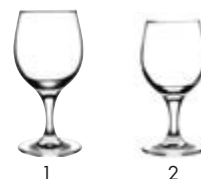

1. **194656 VERRE À EAU**
water glass
copa de agua
29 cl 9²/₃ oz
Ø 7,5 cm - 3 inch
16 cm - 6,3 inch
2. **194655 VERRE À VIN**
wine glass
copa de vino
19 cl 6¹/₃ oz
Ø 7 cm - 2,8 inch
14 cm - 5,5 inch



1. **190536 VERRE À EAU**
water glass
 copa de aqua
45 cl - 15 oz
Ø 8,4 cm - 3,3 inch
20,5 cm - 8,1 inch
2. **190537 VERRE À VIN**
wine glass
 copa de vino
35 cl - 11^{2/3} oz
Ø 7,8 cm - 3,1 inch
19,6 cm - 7,7 inch

3. **184556 FLÛTE À CHAMPAGNE**
champagne flute
 flauta champagne
20 cl - 6^{2/3} oz
Ø 6,7 cm - 3,4 inch
21,2 cm - 8,3 inch
4. **190538 GOBELET**
tumbler
 vaso
47 cl - 15^{2/3} oz
Ø 8,5 cm - 3,3 inch
12,1 cm - 4,8 inch



©Nicolas Broquedis

GALATÉE ÉCLAT



1. **195078 VERRE À EAU**
water glass
 copa de aqua
45 cl - 15 oz
Ø 8,4 cm - 3,3 inch
20,5 cm - 8,1 inch
2. **195079 VERRE À VIN**
wine glass
 copa de vino
35 cl - 11^{2/3} oz
Ø 7,8 cm - 3,1 inch
19,6 cm - 7,7 inch

3. **195077 FLÛTE À CHAMPAGNE**
champagne flute
 flauta champagne
20 cl - 6^{2/3} oz
Ø 6,5 cm - 3,4 inch
21,9 cm - 8,6 inch
4. **195080 GOBELET**
tumbler
 vaso
47 cl - 15^{2/3} oz
Ø 8,5 cm - 3,3 inch
12,1 cm - 4,8 inch



ANYTIME



- | | |
|---|--|
| <p>1. 184570 VERRE À COGNAC
Cognac glass
vaso coñac
61 cl - 20¹/₃ oz
Ø 10,4 cm - 4,1 inch
15,5 cm - 6,1 inch</p> | <p>4. 209814 VERRE À MARGARITA
margarita glass
copa margarita
34 cl - 11¹/₃ oz
Ø 11,1 cm - 4,4 inch
17,2 cm - 6,8 inch</p> |
| <p>2. 190700 VERRE À PORTO/CHERRY
Cherry glass
copa jerez/oporto
10,4 cl - 3¹/₂ oz
Ø 5,6 cm - 2,2 inch
16,9 cm - 6,7 inch</p> | <p>5. 209813 VERRE À SHOOTER
shot glass
copa shooter
4,5 cl - 1¹/₂ oz
Ø 4,6 cm - 1,8 inch
8 cm - 3,1 inch</p> |
| <p>3. 195628 VERRE À MARTINI
martini glass
copa de martini
25 cl - 8¹/₃ oz
Ø 10,6 cm - 4,2 inch
16,8 cm - 6,6 inch</p> | <p>6. 209815 VERRE À COCKTAIL
cocktail glass
copa cocktail
48 cl - 16 oz
Ø 8 cm - 3,1 inch
20,9 cm - 8,2 inch</p> |

VERRINES



- | | |
|--|--|
| <p>1. 184552 VERRINE MUSE
appetizer
vaso
15 cl - 5 oz
Ø 6,4 cm - 2,5 inch
8 cm - 3,1 inch</p> | <p>3. 109439 COUPELLE BRAZIL
appetizer
vaso
30 cl - 10 oz
8,8 cm - 3,5 inch
Ø 13,2 cm - 5,2 inch</p> |
| <p>2. 184598 VERRINE LOOP
appetizer
vaso
19 cl - 6²/₃ oz
Ø 6,7 cm - 2,6 inch
8,1 cm - 3,2 inch</p> | <p>4. 181874 VERRINE RONDO
appetizer
vaso
13 cl - 4¹/₃ oz</p> |
| | <p>5. 181872 VERRINE BORIS
appetizer
vaso
12 cl - 4 oz</p> |

©Nicolas Broquedis

L'abus d'alcool est dangereux pour la santé, à consommer avec modération.
Alcohol is dangerous for your health, drink with moderation.
El abuso del alcohol es peligroso para la salud, consúmase con moderación.



ANYTIME



- 7. 190698 VERRE À EAU**
water glass
copa de agua
45 cl - 15 oz
Ø 8,5 cm - 3,3 inch
15,8 cm - 6,2 inch
- 8. 184569 VERRE À BIÈRE**
beer glass
copa cervesa
39 cl - 13 oz
Ø 7,3 cm - 2,9 inch
17,7 cm - 6,9 inch
- 9. 190701 VERRE À BIÈRE FORME TULIPE**
beer glass
copa cervesa
39 cl - 13 oz
Ø 7,3 cm - 2,9 inch
23,6 cm - 9,3 inch
- 10. 184567 FLÛTE À CHAMPAGNE**
champagne flute
flauta champagne
15 cl - 5 oz
Ø 6,3 cm - 2,5 inch
19,3 cm - 7,6 inch
- 11. 184597 VERRE À CHAMPAGNE**
champagne glass
flauta champagne
21 cl - 7 oz
Ø 6,8 cm - 2,7 inch
20,5 cm - 8,1 inch
- 12. 210281 COUPE À CHAMPAGNE**
champagne glass
copa champagne
23 cl - 7^{2/3} oz
Ø 9,5 cm - 3,7 inch
14,7 cm - 5,8 inch



CARAFES

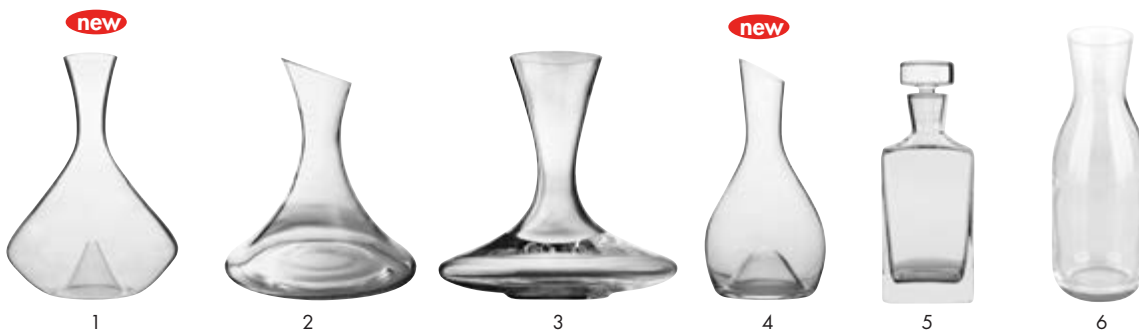

- 1. 210903 DÉCANTEUR AROMATIC**
aromatic decanter
decantador
0,75 l - 25 oz
Ø 19,6 cm - 7,7 inch
26,5 cm - 10,4 inch
- 2. 169728 DÉCANTEUR MILLÉSIME**
millésime decanter
decantador
1,35 l - 45 oz
Ø 20,5 cm - 8 inch
23,5 cm - 9,3 inch
- 3. 188969 DÉCANTEUR VINDEMIA**
vindemia decanter
decantador
1,35 l - 45 oz
Ø 23 cm - 9 inch
24 cm - 9,4 inch
- 4. 210904 DÉCANTEUR NECTAR**
nectar decanter
decantador
1 l - 33^{1/3} oz
Ø 13,5 cm - 5,3 inch
24,5 cm - 9,6 inch
- 5. 199027 CARAFE À WHISKY ANYTIME**
whisky carafe
jarra de whisky
1,2 l - 40 oz
Ø 21,6 cm - 8,5 inch
- 6. 202639 CARAFE EVENTO**
evento carafe
jarra evento
1,2 l - 40 oz
Ø 10 cm - 3,9 inch
27,5 cm - 10,8 inch



MUSE



- | | |
|---|---|
| <p>1. 184555 GOBELET HAUT
 <i>high tumbler</i>
 vaso alto
 36 cl - 12 oz
 Ø 6,8 cm - 2,7 inch
 14,2 cm - 5,6 inch</p> | <p>3. 184553 GOBELET BAS
 <i>low tumbler</i>
 vaso bajo
 23 cl - 7^{2/3} oz
 Ø 7,6 cm - 3 inch
 9,2 cm - 3,6 inch</p> |
| <p>2. 184554 GOBELET BAS
 <i>low tumbler</i>
 vaso bajo
 33 cl - 11 oz
 Ø 8 cm - 3,1 inch
 10,2 cm - 4 inch</p> | <p>4. 184552 GOBELET BAS/VERRINE
 <i>low tumbler/appetizer</i>
 vaso bajo
 15 cl - 5 oz
 Ø 6,4 cm - 2,5 inch
 8 cm - 3,1 inch</p> |

L'abus d'alcool est dangereux pour la santé, à consommer avec modération.
 Alcohol is dangerous for your health, drink with moderation.
 El abuso del alcohol es peligroso para la salud, consúmase con moderación.

CURL



- | | |
|---|---|
| <p>1. 189777 GOBELET BAS
 <i>low tumbler</i>
 vaso bajo
 47 cl - 15^{2/3} oz
 Ø 8,7 cm - 3,4 inch
 12 cm - 4,7 inch</p> | <p>2. 189776 GOBELET BAS
 <i>low tumbler</i>
 vaso bajo
 33,5 cl - 11^{0,5/3} oz
 Ø 7,5 cm - 2,9 inch
 10,5 cm - 4,1 inch</p> |
|---|---|

COSMOPOLITAIN

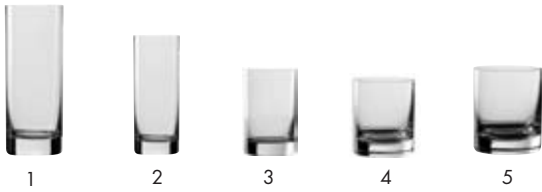

- | | |
|---|--|
| <p>1. 189775 GOBELET HAUT
 <i>high tumbler</i>
 vaso alto
 45 cl - 1,5 oz
 Ø 6,6 cm - 2,6 inch
 17,8 cm - 7 inch</p> | <p>4. 184586 GOBELET BAS
 <i>low tumbler</i>
 vaso bajo
 32 cl - 10^{2/3} oz
 Ø 8 cm - 3,1 inch
 9,4 cm - 3,7 inch</p> |
| <p>2. 184589 GOBELET HAUT
 <i>high tumbler</i>
 vaso alto
 35 cl - 11^{2/3} oz
 Ø 6,5 cm - 2,5 inch
 14,4 cm - 5,6 inch</p> | <p>5. 189774 GOBELET BAS
 <i>low tumbler</i>
 vaso bajo
 42 cl - 14 oz
 Ø 8,5 cm - 3,3 inch
 10,6 cm - 4,2 inch</p> |
| <p>3. 184588 GOBELET HAUT
 <i>high tumbler</i>
 vaso alto
 29 cl - 9^{2/3} oz
 Ø 7 cm - 2,8 inch
 10,7 cm - 4,2 inch</p> | |



©Julie Anisiau

LOOP



- | | |
|--|---|
| <p>1. 184601 GOBELET HAUT
 <i>high tumbler</i>
 vaso alto
 39 cl - 13 oz
 Ø 6,6 cm - 2,6 inch
 14,5 cm - 5,7 inch</p> | <p>3. 184598 GOBELET BAS/VERRINE
 <i>low tumbler/appetizer</i>
 vaso bajo
 19 cl - 6^{2/3} oz
 Ø 6,7 cm - 2,6 inch
 8,1 cm - 3,2 inch</p> |
| <p>2. 184600 GOBELET BAS
 <i>low tumbler</i>
 vaso bajo
 35 cl - 11^{2/3} oz
 Ø 7,9 cm - 3,1 inch
 9,1 cm - 3,6 inch</p> | |





DOLCE



1



2



3



4

- | | |
|---|---|
| <p>1. 169851 GOBELET TRANSPARENT
transparent high tumbler
vaso alto transparente
57 cl - 19 oz
Ø 6,7 cm - 2,6 inch
11,5 cm - 4,5 inch</p> | <p>3. 169854 GOBELET AMÉTHYSTE
amethyste tumbler
vaso nawa
43 cl - 14^{1/3} oz
Ø 6,1 cm - 2,4 inch
10 cm - 3,9 inch</p> |
| <p>2. 169852 GOBELET TRANSPARENT
transparent tumbler
vaso transparente
43 cl - 14^{1/3} oz
Ø 6,1 cm - 2,4 inch
10 cm - 3,9 inch</p> | <p>4. 169856 GOBELET HÉMATITE
hématite tumbler
vaso gris
43 cl - 14^{1/3} oz
Ø 6,1 cm - 2,4 inch
10 cm - 3,9 inch</p> |





1

199461



2

199462



3

174510



4

174511



5

180939



6

180936



7

206936

GOBELET

tumbler

vaso

29 cl - 9²/₃ oz

Ø 7,2 cm - 2,8 inch

9,5 cm - 3,7 inch



ALLEGRO

©Studio Rougereau



1

199460



2

171631



3

171632



4

171633



5

171630

GOBELET

tumbler

vaso

34 cl - 11¹/₃ oz

Ø 8,5 cm - 3,3 inch

10 cm - 3,9 inch

MAMBO



HOLLOWWARE

Through the steel objects specially dedicated to the table, the art of service and the tasting experience, Degrenne demonstrates the wealth of its craftsmanship expertise.

Carefully shaped pieces with refined lines to offer an elegant service which fits perfectly with all of our ranges.

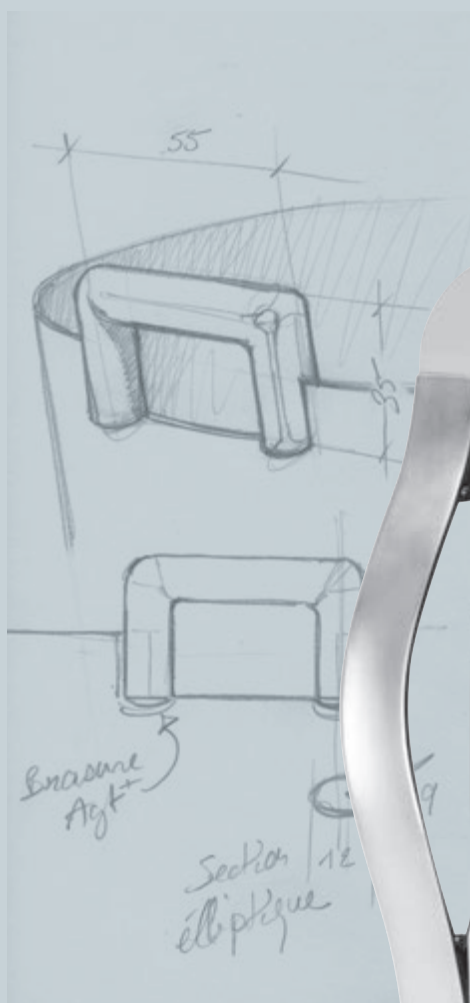

ORFEBRERÍA

A través de los objetos de acero dedicados a la mesa, al servicio y a la degustación, Degrenne expresa la riqueza de su oficio de orfebre. Piezas de forma con líneas refinadas para ofrecer un servicio elegante en perfecta armonía con el conjunto de nuestras gamas.

LA PLATERIE

A travers des objets en acier dédiés à la table, au service et à la dégustation, Degrenne exprime la richesse de son métier d'orfèvre. Des pièces de forme aux lignes raffinées pour offrir un service élégant tout en s'accordant parfaitement avec l'ensemble de nos gammes.

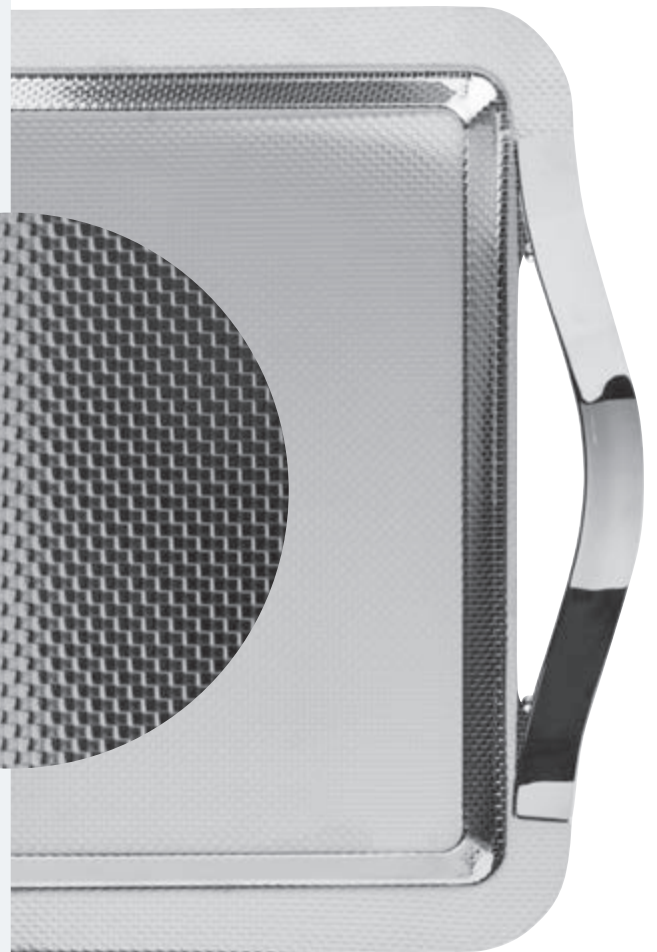
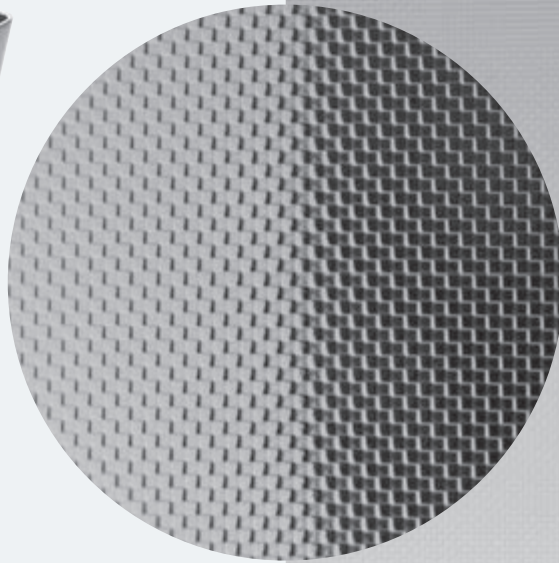



1



2



3



4

**1. PLATEAU RECTANGULAIRE AVEC ANSES
GASTRONORM 2/1**

servicing tray with handles
bandeja rectangular con asa

65 x 53 cm - 25,6 x 20,8 inch

✱ **211886**
☑ **213857**

2. PLATEAU RECTANGULAIRE AVEC ANSES

servicing tray with handles
bandeja rectangular con asa

60 x 40 cm - 23,6 x 15,7 inch

✱ **211887**
☑ **213858**

**3. PLATEAU RECTANGULAIRE SANS ANSES
GASTRONORM 1/2**

servicing tray without handles
bandeja rectangular sin asa

32,5 x 26,5 cm - 12,8 x 10,4 inch

✱ **211888**
☑ **213859**

4. PLATEAU SANS ANSES

servicing tray without handles
bandeja rectangular sin asa

22 x 13 cm - 8,7 x 5,5 inch

✱ **211889**
☑ **213860**



1 - 2 - 3



4



5 - 6 - 7

**1. PLATEAU RECTANGULAIRE AVEC ANSES
GASTRONORM 2/1**

servicing tray with handles
bandeja rectangular con asa

65 x 53 cm - 25,6 x 20,8 inch

✱ **185023**
☑ **186459**

2. PLATEAU RECTANGULAIRE AVEC ANSES

servicing tray with handles
bandeja rectangular con asa

60 x 40 cm - 23,6 x 15,7 inch

✱ **185022**
☑ **186460**

3. PLATEAU RECTANGULAIRE AVEC ANSES

servicing tray with handles
bandeja rectangular con asa

77 x 55 cm - 30,3 x 21,7 inch

✱ **185018**
☑ **186458**

**4. PLATEAU RECTANGULAIRE SANS ANSES
GASTRONORM 1/2**

servicing tray without handles
bandeja rectangular sin asa

32,5 x 26,5 cm - 12,8 x 10,4 inch

✱ **185019**
☑ **186463**

5. PLATEAU ROND

round tray
bandeja redonda

42 cm - 16,5 inch

✱ **185024**
☑ **186457**

6. PLAT OVALE

ovale dish
fuente ovalada

46 x 31 cm - 18,1 x 12,2 inch

✱ **183019**
☑ **186451**

41,5 x 28 cm - 16,1 x 11 inch

✱ **183018**
☑ **186450**

38,5 x 25,5 cm - 15,10 x 10 inch

✱ **183017**
☑ **186449**

7. PLAT POISSON

fish dish
fuente para pescado

60 x 27 cm - 23,6 x 10,6 inch

✱ **183021**
☑ **186453**

NEWPORT

new NEWPORT CUBIQUE



Anses ergonomiques pour un bon confort d'utilisation. Les plateaux sont empilables et sont aux normes Gastronomie pour 3 des 6 tailles. Adaptés aux buffets, room service...

Handles are ergonomically shaped for comfort. The trays are stackable, and three of the six sizes conform to Fine Dining standards. Suitable for the buffet table, room service etc...

Asas ergonómicas para una buena comodidad de utilización. Las bandejas son apilables y cumplen con las normas de gastronomía en 3 de los 6 tamaños. Adaptadas a los bufets, servicio de habitaciones, etc.



1. SEAU CHAMPAGNE 1 BOUTEILLE

Champagne bucket 1 bottle
champanera 1 botella
Ø 20 cm / H 22,5 cm - 7,9/8,9 inch

✳ **186030**
 📦 **188894**

2. SEAU CHAMPAGNE 2 BOUTEILLES

Champagne bucket 2 bottles
champanera 2 botellas
Ø 24 cm / H 25,5 cm - 9,4/10 inch

✳ **184180**
 📦 **188895**

3. PORTE SEAU CHAMPAGNE 1 OU 2 BOUTEILLES

Champagne bucket stand (1 or 2 bottles)
portacubo 1/2 botellas
H 63,5 cm - 25 inch

✳ **185607**
 📦 **188893**

4. SEAU À GLACE AVEC COUVERCLE

ice bucket with lid
hielera
Ø 15 cm / H 16 cm - 5,9/6,3 inch

✳ **184181**
 📦 **188896**

5. COUPELLE EMPILABLE

stackable bowl
bol
 ✳ **185880 Ø 9 cm / H 3 cm - 3,5/1,2 inch**
 📦 **185879 Ø 9 cm / H 5 cm - 3,5/2 inch**

6. 185882 - SUPPORT GRANDE MÉNAGÈRE

big stand for accessories
soporte grande

Une ligne élégante pour un **seau à Champagne empilable**.
Un porte seau adapté à la fois aux seaux 1 et 2 bouteilles.

*Champagne buckets can be stacked to save space.
The bucket stand can hold the one and two bottle buckets.*

Una línea elegante para **una champanera apilable**.
Un pie porta champanera adaptado a la vez para las champaneras de 1 y 2 botellas.



©Nicolas Broquedis

NEWPORT BAR



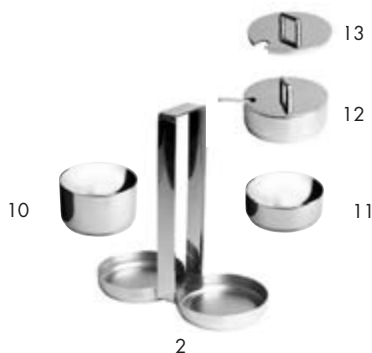

1. **185892 - ENSEMBLE HUILE/VINAIGRE**
big stand with oil/vinegar cruet
conjunto aceite/vinagrera

2. **185882 - SUPPORT GRANDE MÉNAGÈRE**
big stand for accessories
soporte grande

3. **185884 - ADAPTATEUR HUILE/VINAIGRE**
oil & vinegar cruet
adaptator aceite y vinagrera

4. **193228 - VERRINE HUILE & VINAIGRE**
oil vinegar cruet
aceitera

5. **193136 - ENSEMBLE SALIÈRE/POIVRIÈRE ET HUILE/VINAIGRE**
big stand with salt & pepper cellar set and oil/vinegar cruet
conjunto sal/pimienta y aceite/vinagrera

6. **185883 - ADAPTATEUR SEL/POIVRE**
salt & pepper adapter
adaptator salero y pimentero

7. **185889 - VERRINE À SEL**
salt cellar
salero

8. **191636 - VERRINE À POIVRE**
pepper cellar
pimentero

9. **185891 - ENSEMBLE SALIÈRE/POIVRIÈRE**
big stand with salt & pepper cellar set
conjunto sal/pimienta

10. **185879 - COUPELLE EMPILABLE**
stackable bowl
bol
Ø 9 cm / H 5 cm - 3,5/2 inch

11. **185880 - COUPELLE EMPILABLE**
stackable bowl
bol
Ø 9 cm / H 3 cm - 3,5/1,2 inch

12. **185893 - POT À CUILLER (3CM)**
cruet with lid and spoon (1,2 inch)
bol con tapa y cuchara

13. **185885 - COUVERCLE COUPELLE 9 CM**
lid for 3,5 inch bowl
tapa para bowl 3,5 cm

14. **BEURRIER**
butter dish
mantequillera indiv.
7 cm - 2,8 inch

★ **185307**
☑ **186455**

15. **190255 - SOCLE BEURRIER PORCELAINE**
butter dish porcelain
mantequillera sin tapa

16. **SAUCIÈRE**
sauce boat
bol
20 cl - 6,6 inch

★ **186198**
☑ **185456**

17. **PORTE SUCRE/CENTRE DE TABLE**
sugar holder/table centerpiece
centro de mesa
★ **208862 - 5 cm - 2 inch**
☑ **211397 - 6,4 cm - 2,5 inch**

NEWPORT ACCESSOIRES

ACCESSORIES



NEWPORT PORCELAINE

PORCELAIN - PORCELANA



1. **CAFETIÈRE**
coffee pot
cafetera
0,3 l - 10 oz
★ 182335
★ 184606



- 0,6 l - 20 oz
★ 182334
★ 184605

- 1,50 l - 50 oz
★ 182336
★ 184607

2. **THÉIÈRE**
tea pot
tetera
0,35 l - 11²/₃ oz
★ 182337
★ 184608



- 0,7 l - 23¹/₃ oz
★ 182338
★ 184609

3. **PICHET**
water pitcher w/ice guard
jarra
2 l - 66²/₃ oz
★ 183327
★ 184613



4. **CRÉMIER**
cream jug
lechera
0,15 l - 5 oz
★ 182339
★ 184610



- 0,3 l - 10 oz
★ 182340
★ 184611

5. **SUCRIER**
sugar bowl with lid
azucarero con tapa
0,35 l - 11²/₃ oz
★ 182341
★ 184612



6. **POT ISOTHERME**
insulated pot
jarra isotérmica
0,35 l - 11²/₃ oz
★ 190374
★ 190380



- 0,7 l - 23¹/₃ oz
★ 190375
★ 190381

- 1,20 l - 40 oz
★ 190376
★ 190382

7. **FILTRE POUR POT ISOTHERME**
strainer for insulated pot
filtro para jarra isotérmica
0,35 l - 11²/₃ oz
190377

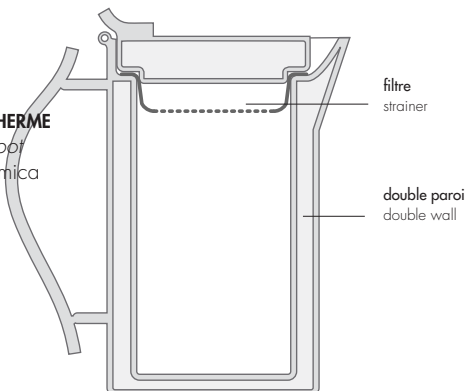

- 0,7 l - 23¹/₃ oz
190378

- 1,20 l - 40 oz
190379

1. **207756 - TASSE ESPRESSO**
espresso cup
taza de espresso
10 cl - 3¹/₃ oz



2. **207759 - SOUCOUPE ESPRESSO**
espresso saucer
plato espresso
12,5 cm - 4,9 inch



3. **207757 - TASSE LUNGO**
lungo cup
taza de lungo
20 cl - 6²/₃ oz



4. **207760 - SOUCOUPE LUNGO**
lungo saucer
plato lungo
15 cm - 6 inch

5. **207758 - TASSE DÉJEUNER**
breakfast cup
taza desayuno
40 cl - 13¹/₃ oz

6. **207759 - SOUCOUPE DÉJEUNER**
breakfast saucer
plato desayuno
18,5 cm - 7,3 inch

7. **207762 - CRÉMIER**
cream bowl
lechera
10 cl - 3¹/₃ oz

8. **207763 - THÉIÈRE**
tea pot
tetera
40 cl - 13¹/₃ oz

9. **207764 - THÉIÈRE**
tea pot
tetera
80 cl - 27,05 oz



NEWPORT CAFÈTERIE

COFFEE POT - CAFETERA



VERTIGE

1. **156172 - SEAU À CHAMPAGNE INOX**
stainless steel champagne bucket
 champanera
 Ø 20 cm / H 20 cm - 7,9 / 7,9 inch



2. **156144 - RAFRAÎCHISSEUR**
bottle cooler
 enfriador
 Ø 16 cm / H 20 cm - 6,3 / 7,9 inch



3. **160495 - SEAU À GLACE AVEC (GRILLE)**
ice bucket with (ring)
 hielera (con rejá)
 Ø 13,5 cm/H 14 cm - 5,3/5,5 inch



4. **156150 - PLATEAU RECTANGULAIRE DE SERVICE**
rectangular serving tray
 bandeja rectangular
 53 x 33 cm - 20,9 x 13 inch



5. **160501 - DESSOUS DE BOUTEILLE**
bottle coaster
 posabotella
 Ø 13 cm / H 3,5 cm - 5,1 x 1,4 inch



NORMANDIE

1. **148604 - SEAU À CHAMPAGNE**
Champagne bucket
 champanera
 Ø 19 cm / H 19,5 cm - 7,5/7,7 inch



2. **148606 - SEAU À GLACE**
ice bucket
 hielera/c asas
 Ø 13 cm/H 14 cm - 5,1/5,5 inch



ACCESSOIRES ACCESSORIES

1. **CLOCHE ASSIETTE**
dome cover
 campana
 Ø 14,8 cm - 5,8 inch
 ✱ 182301
 184476



- Ø 24 cm - 9,4 inch
 ✱ 182614
 184477

2. **CLOCHE ASSIETTE**
dome cover
 campana
 Ø 22 cm - 8,7 inch
 ✱ 044112
 101510



- Ø 26 cm - 10,2 inch
 ✱ 044113
 101512

3. **CORBILLE À PAIN RONDE EN FIL**
round bread basket
 panera redonda
 Ø 20,5 cm/H 7,5 cm - 8,1/h 3 inch
 ✱ 120522
 131115



- Ø 17,5 cm/H 6 cm - 6,9/h 2,4 inch
 ✱ 128910
 131114

4. **CORBILLE À PAIN OVALE EN FIL**
oval bread basket
 panera ovalada
 Ø 24x17cm/H 7,5 cm - 9,4x6,7/h3 inch
 ✱ 128912
 131117

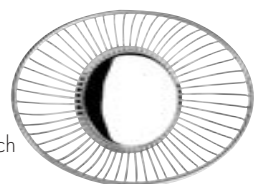

- Ø 19,5x15 cm/H 6 cm - 7,9x6/h 2,4 inch
 ✱ 128911
 131118

ACCESSOIRES

ACCESSORIES



5. BOL RINCE DOIGTS

finger bowl
lavadededos

Ø 11 cm/H 4 cm - 4,3/h 1,6 inch

★ 159597
101453



6. PLATEAU MONNAIE

cash tray/underliner, cream & sugar
bandeja moneda

16x20 cm - 6,3 x 7,9 inch

★ 120537
129796



7. 004013 - PINCE À ESCARGOT

snail tong

pinzas caracoles

16 cm - 6,3 inch



8. PINCE À PAIN

bread tong

pinzas pan

23 cm - 9,1 inch

★ 204498
101492



9. PINCE À HOMARD

lobster craker

tenacillas para bogavante

18,5 cm - 7,3 inch

★ 204497
101493



10. PINCE À SERVIR

serving tong

pinzas para servir

29,5 cm - 11,6 inch

★ 204499
184355



11. CISEAUX À GÂTEAUX

pastry scissors/ tong

pinzas para pasteles

20 cm - 7,9 inch

★ 204496
101494



12. 130994 - CUILLER À TOAST

toast spoon

cuchara para servir tostados

11,8 cm - 4,65 inch

★ 204496
101494



13. 004014 - PINCE À GLACE

ice tong

pinza para hielo

16 cm - 6,3 inch

★ 204496
101494



14. PINCE À SUCRE

sugar tong

pinza para azúcar

11,5 cm - 4,5 inch

★ 002191
129797



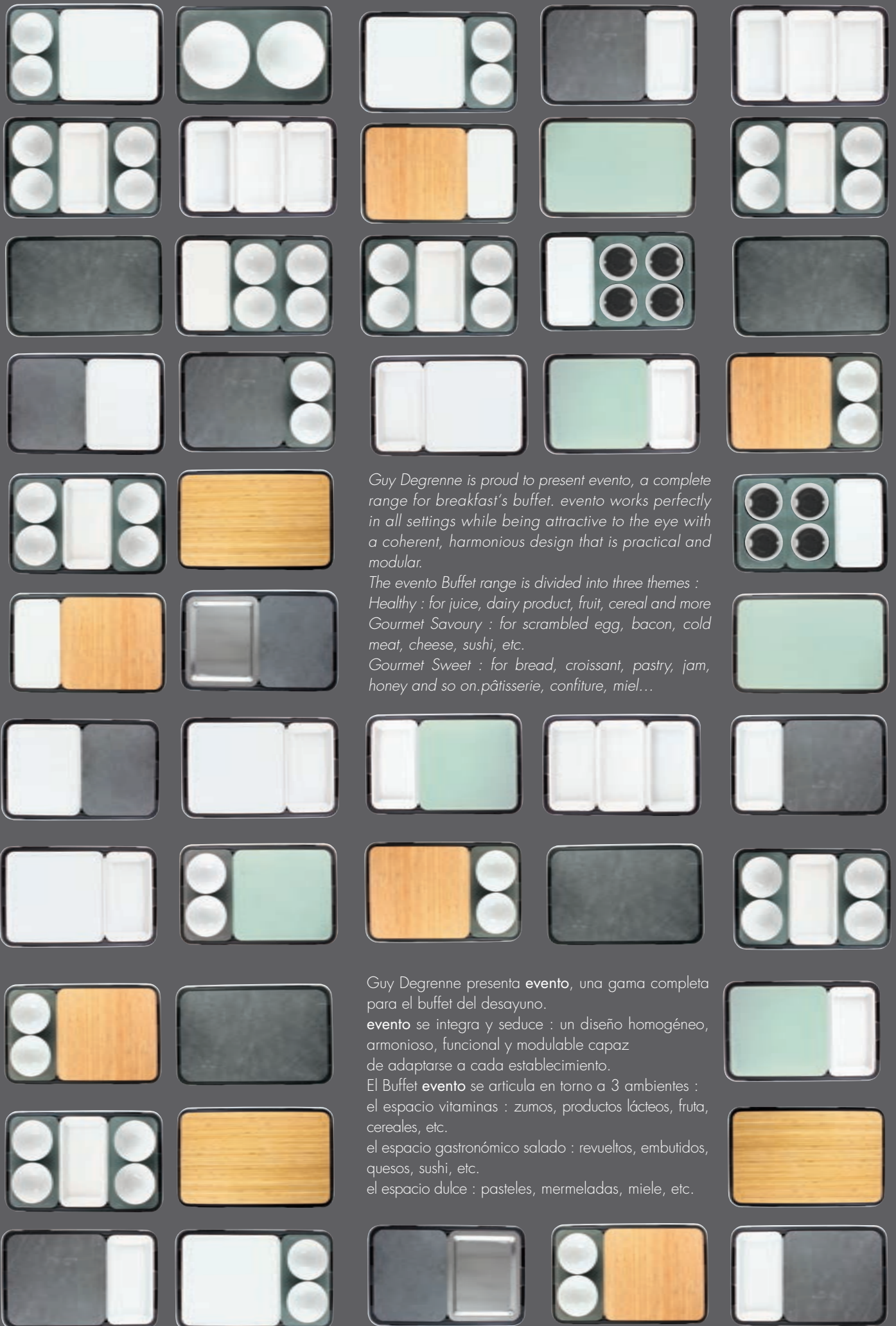

Guy Degrenne is proud to present evento, a complete range for breakfast's buffet. evento works perfectly in all settings while being attractive to the eye with a coherent, harmonious design that is practical and modular.

*The evento Buffet range is divided into three themes :
 Healthy : for juice, dairy product, fruit, cereal and more
 Gourmet Savoury : for scrambled egg, bacon, cold meat, cheese, sushi, etc.*

Gourmet Sweet : for bread, croissant, pastry, jam, honey and so on. pâtisserie, confiture, miel...

Guy Degrenne presenta evento, una gama completa para el buffet del desayuno.

evento se integra y seduce : un diseño homogéneo, armonioso, funcional y modulable capaz de adaptarse a cada establecimiento.

*El Buffet evento se articula en torno a 3 ambientes :
 el espacio vitaminas : zumos, productos lácteos, fruta, cereales, etc.*

el espacio gastronómico salado : revueltos, embutidos, quesos, sushi, etc.

el espacio dulce : pasteles, mermeladas, miele, etc.



Guy Degrenne présente **evento**, une gamme complète pour le Buffet capable de s'adapter à chaque établissement avec son design homogène, harmonieux, fonctionnel et modulable.

evento s'articule autour de 3 pôles :

l'espace Vitaminé : jus de fruits, produit laitier, fruit, céréale...

l'espace Gourmet Salé : œuf brouillé, bacon, charcuterie, fromage, sushi...

l'espace Gourmand Sucré : pain, viennoiserie, pâtisserie, confiture, miel...

Buffet

O
+
N
E
V
E

1. 202857 - CHAFING DISH MIROIR

chafing dish mirror

chafing dish acabado brillo

202856 - CHAFING DISH BROSSÉ

chafing dish brushed

chafing dish acabado satinado

Acier inoxydable - Porcelaine - Verre trempé

Stainless steel, porcelain, tempered glass

Acero inoxidable, porcelana, vidrio templado

Ø 35,5 cm - P 40 cm - H 15 cm

Ø 14 inch - D 16,1 inch - H 5,9 inch



2. 203005 - SUPPORT CHAFING DISH ACIER INOXYDABLE BRILLANT

stand chafing dish mirror - stainless steel mirror

sopORTE chafing dish brillo - acero inoxidable brillo

202859 - SUPPORT CHAFING DISH ACIER INOXYDABLE BROSSÉ

stand chafing dish brushed - stainless steel brushed

sopORTE chafing dish satinado - acero inoxidable satinado

Pour résistance électrique ou brûleur avec gel combustible

for electrical and/or sterno heating purposes

para resistencia eléctrica o calentador externo

Ø 35 cm - P 40 cm - H 12,5 cm

Ø 13,8 x 15,8 x 4,9 inch



Couvercle en verre transparent

Clear glass cover

Cubierta de vidrio transparente

Système de récupération d'eau de condensation dans le bac porcelaine.

Condensation water collection system in the porcelain insert.

El agua condensada se recoge mediante un sistema de recolección en la base de porcelana.

Encoches pour les couverts de service

The notch for the serving cutlery.

El agua condensada se recoge mediante un sistema de la ranura para las piezas de servicio.

3. 202634 - BAC PORCELAINE POUR CHAFING DISH

porcelain insert for chafing dish

bandeja de porcelana para chafing

Ø 35,5 x H 7,2 cm

Ø 14 x h 2,8 inch

contenance 3L - capacity 100 oz



4. 202635 - 1/2 BAC PORCELAINE POUR CHAFING DISH

1/2 porcelain insert for chafing dish

1/2 bandeja de porcelana para chafing

L 29 x l15 x H 4,5 cm

l 11,4 x w 5,9 x h 1,8 inch

contenance 1L - capacity 33^{1/3} oz



5. 203470 - COUVERCLE AVEC GOUTTIÈRE ACIER ET VERRE TREMPÉ

lid with stainless steel gutter, tempered glass

tapa en acero inox y vidrio templado

Ø 33 cm - Ø 13 inch



6. 202860 - RÉSISTANCE 220 /240 V AVEC RÉGULATEUR DE TEMPÉRATURE

203468 - RÉSISTANCE 110 /120 V AVEC RÉGULATEUR DE TEMPÉRATURE

heating element - heat adjustable

resistencia con regulador de temperatura

20x20 cm - 7,9 x 7,9 inch



7. 202861 - PORTE-BRÛLEUR POUR GEL COMBUSTIBLE

burner holder - quemador

acier - steel - acero inoxidable

Ø 9 cm - H 6 cm - Ø 3,5 inch - h 2,4 inch



8. 120519 - PINCE À SERVIR

serving tong

pinza de servir

29,5 cm - 11,6 inch

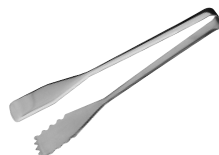

Le Chafing dish, par son design contemporain alliant acier, porcelaine et verre offre à votre buffet une présentation soignée et raffinée.

The chafing dish, with its contemporary design that combines steel, porcelain and glass, brings a smart and sophisticated touch to your buffet display.

El Chafing dish, por su diseño contemporáneo que combina acero, porcelana y cristal ofrece a su buffet una presentación cuidada y refinada.



1. **202864 - MODULE ACIER FINITION MIROIR + BAC PLASTIQUE**
stainless steel mirror refrigerated set + plastic tray
 modulo refrigerado inoxidable + bandeja

2. **202865 - MODULE ACIER FINITION BROSSÉE + BAC PLASTIQUE**
stainless steel brushed refrigerated set + plastic tray
 modulo refrigerado inoxidable satinado + bandeja

3. **202867 - MODULE ACIER ROUGE LAQUÉ+ BAC PLASTIQUE**
red refrigerated set + plastic tray
 rojo refrigerado + bandeja

4. **202868 - MODULE ACIER BLANC LAQUÉ+ BAC PLASTIQUE**
white refrigerated set + plastic tray
 blanco refrigerado + bandeja

5. **202868 - MODULE ACIER NOIR MÉTALLISÉ + BAC PLASTIQUE**
metallic black set + plastic tray
 negro refrigerado + bandeja

6. **202868 - MODULE ACIER GRIS + BAC PLASTIQUE**
grey set + plastic tray
 gris refrigerado + bandeja



7. **208357 - PLAQUE RÉFRIGÉRANTE EUTECTIQUE**
black cooling block, eutectique
 nero placa refrigerante
48 x 28 x 3 cm - 18,9 x 11 x 1,2 inch



8. **202866 - BAC PLASTIQUE**
plastic tray
 bandeja
56 x 35,5 x 8 cm - 22 x 14 x 3,1 inch

9. **202628 - PLATEAU PORCELAINE GN 2/3**
white enameled porcelain tray GN 2/3
 porcelana blanca esmaltada
35,4x32,5 cm - 13,9 x 12,8 inch



10. **202629 - PLATEAU PORCELAINE GN 1/2**
white enameled porcelain tray GN 1/2
 porcelana blanca esmaltada
26,5 x 32,5 cm - 10,4 x 12,8 inch



11. **202627 - PLATEAU PORCELAINE GN 1/3**
white enameled porcelain tray GN 1/3
 porcelana blanca esmaltada
17,5 x 32,5 cm - 6,9 x 12,8 inch



12. **202630 - PLAT CREUX PORCELAINE GN 1/3**
white enameled porcelain deep dish GN 1/3
 porcelana blanca esmaltada
17,5 x 32,5 cm - 6,9 x 12,8 inch



13. **202873 - PLATEAU ACIER 18-10 FINITION STANDARD GN 1/1**
18-10 stainless steel tray GN 1/1, standard finish
 bandeja inoxidable
53x 32,5 cm - 20,9 x 12,8 inch



14. **185021 - NEWPORT PLATEAU ACIER 18-10 FINITION MIROIR GN 1/1**
Newport 18-10 stainless steel tray GN 1/1, mirror finish
 Newport bandeja inoxidable
53x 32,5 cm - 20,9 x 12,8 inch



15. **185019 - NEWPORT PLATEAU ACIER 18-10 FINITION MIROIR GN 1/2**
Newport 18-10 stainless steel tray GN 1/2, mirror finish
 Newport bandeja inoxidable
32,5 x 26,5 cm - 12,8 x 10,4 inch



16. **202915 - PLATEAU VERRE GN 1/1 - 6 MM**
tempered glass tray GN 1/1 - 0,2 inch
 lado vidrio - 6 mm
53 x 32,5 cm - 20,9 x 12,8 inch



17. **202916 - PLATEAU VERRE GN 2/3 - 6 MM**
tempered glass tray GN 2/3 - 0,2 inch
 lado vidrio - 6 mm
35,4 x 32,5 cm - 13,9 x 12,8 inch



18. **202919 - PLATEAU BAMBOU GN 1/1**
bamboo tray GN 1/1
 bamboo vidrio
53 x 32,5 cm - 20,9 x 12,8 inch



19. **202920 - PLATEAU BAMBOU GN 2/3**
bamboo tray GN 2/3
 bamboo vidrio
35,4 x 32,5 cm - 13,9 x 12,8 inch



20. **183340 - PLANCHE À DÉCOUPER**
cutting board
 tabla de cortar
35 x 26,5 cm - 13,8 x 10,4 inch



21. **202911 - PLATEAU ARDOISE GN 1/1**
slate tray GN 1/1
 pizarra
53 x 32,5 cm - 20,9 x 12,8 inch

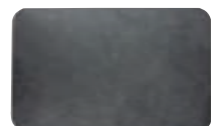

22. **202912 - PLATEAU ARDOISE GN 2/3**
slate tray GN 2/3
 pizarra
35,4 x 32,5 cm - 13,9 x 12,8 inch



23. **202913 - PLATEAU ARDOISE GN 1/2**
slate tray GN 1/2
 pizarra
26,5 x 32,5 cm - 10,4 x 12,8 inch



evento VITAMINÉ



©studio Rougereau

evento+

Tous les plateaux, aux dimensions GN, s'adaptent sur le module réfrigéré.
All these trays, with Gastronorm Industry standard sizes are fitting in the refrigerated set.
Todas las bandejas, con medidas standard GN se adaptan a los módulos refrigerados.

24. 202917 - PLATEAU ACRYLIQUE GN 1/1 - 2 TROUS - 10 MM

acrylic tray GN 1/1 - 2 holes - 0,4 inch
acrílico lado - 2 agujeros - 10 mm
53 x 32,5 cm - 20,9 x 12,8 inch



25. 202918 - PLATEAU ACRYLIQUE GN 1/3 - 2 TROUS - 10 MM

acrylic tray GN 1/3 - 2 holes - 0,4 inch
acrílico lado - 2 agujeros - 10 mm
17,5 x 32,5 cm - 6,9 x 12,8 inch



26. 202625 - BOL BLANC EVENTO

evento white bowl
bol blanco evento
22 cm - 8,7 inch - 2 l - 67 oz



27. 203331 - BOL WENGÉ EVENTO

evento brown bowl
bol wengé evento
22 cm - 8,7 inch - 2 l - 67 oz



28. 203331 - BOL BLANC MODULO

modulo white bowl
bol blanco modulo
14 cm - 5,5 inch - 75 cl - 25 oz



29. 202871 - COUVERCLE MODULE RÉFRIGÉRÉ / POIGNÉE ACIER INOXYDABLE

lid for refrigerated set /stainless steel handle
tapa/acero inoxidable
56 x 35 x 19 cm - 22 x 13,8 x 7,6 inch



Urne à jus de fruits avec tube acier pour glace pilée
 fruit juice urn with central steel tube to hold crushed ice
 dispensador de zumos dotado con un tubo central de acero

1. URNE À JUS DE FRUIT

fruit juice urn

dispensador de zumos

202921 - miroir - *mirror* - brillo

202922 - brossé - *brushed* - satinado

Acier 18-10 - fût SAN - socle acrylique

stainless 18-10 - container SAN, acrylic stand

acero 18-10 - contenedor SAN, soporte acrílico

4L (avec tube pour glace) L 20 x P 32 x h 45 cm

135 oz (with the ice tube) 4L (con el tubo para hielo)

w 7,9 x d12,6 x h 17,7 inch

2. COUVERCLE URNE MIROIR

lid for mirror finish dispenser

tapa para dispensador en brillo

202881 - Couvercle urne miroir

202891 - Couvercle urne brossé

lid for brushed finish dispenser

tapa para dispensador satinada

Acier 18-10

stainless 18-10

acero 18-10

Ø 17,9 cm - 7 inch

3. 202884 - TUBE POUR GLACE

ice tube

tubo para hielo

Acier 18-10

stainless 18-10

acero 18-10

Ø 9,2 cm - 3,6 inch

4. 202883 - FÛT CYLINDRIQUE URNE

container for dispenser

contenedor para el dispensador

SAN - SAN

5L - Ø 17,7 cm x H 25,5 cm

169 oz - Ø 6,9 x 10 inch

5. 202888 ROBINET

faucet - grifo

Acier + ABS

stainless steel, ABS

acero inoxidable

6. 045963 - GRILLE ACIER POUR GOUTTES

steel grid drop collector

rejilla de acero para recoger el goteo

Acier 18-10

stainless 18-10

acero 18-10

Ø 9 cm - 3,6 inch

7. 202890 - BASE ACIER MIROIR URNE

steel stand mirror finish for dispenser

soporte acero brillo para dispensador

202889 - BASE ACIER BROSSÉ URNE

steel stand brushed finish for dispenser

soporte de acero satinado para dispensador

Acier 18-10 - stainless 18-10

acero 18-10

Ø 17,6 cm - H 19 cm

Ø 6,9 x 7,5 inch

8. 202887 - SOCLE ACRYLIQUE URNE

stand for dispenser

base del dispensador

Acrylique - acrylic

20 x 32 cm - 7,9 x 12,6 inch

épaisseur 2 cm - thickness 0,8 inch

espesor 2 cm



Bouchon verseur en silicone pour une meilleure hygiène.
 Higienic silicone pouring stopper.
 Tapón de silicona para mayor higiene y control del vertido.

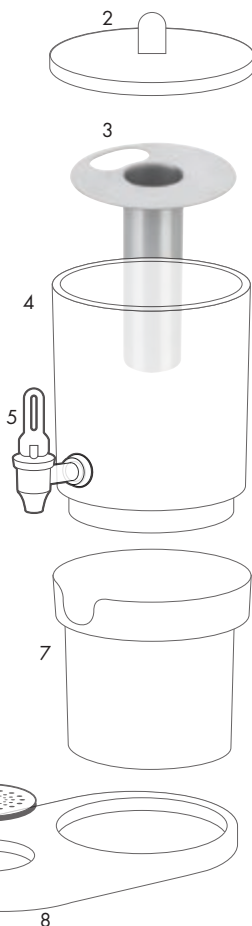

9. 202636 - CARAFE À LAIT - 1,2 L

milk jug - 40 oz

botella para leche

Porcelaine - *porcelain* - porcelana

Ø 10,5 cm - H 27,5 cm

Ø 4 x 10,8 inch

10. 202639 - CARAFE À JUS DE FRUIT - 1,2 L

juice/beverage carafe - 40 oz

botella para zumos cristal

Cristallin soufflé bouche

hand blown crystalline

cristal soplado en boca

Ø 10 cm - H 27,5 cm

Ø 3,9 x 10,8 inch

11. 202855 - BOUCHON DE CARAFE

stopper for Carafe

tapón para botella

Silicone - *silicone* - silicona

Ø 6,5 cm - H 4,2 cm

Ø 2,6 x 1,7 inch

evento

VITAMINÉ



Un design commun pour les deux carafes, des matériaux distincts pour chaque usage : l'opacité de la porcelaine pour le lait, la transparence du verre pour les jus.

The same design for both carafes, in different materials for different uses : opaque porcelain for milk, transparent glass for juice.

Un diseño común para las dos jarras, con materiales distintos para cada uso : la opacidad de la porcelana para la leche y la transparencia del cristal para los zumos.



1. **202904 - SUPPORT RECTANGULAIRE, NIVEAU 1**
rectangular tray, level 1
 soporte rectangular, nivel 1
L 44 x P 30,8 x h 10,8 cm w 17,3 x d 12,1 x h 4,3 inch
2. **202905 - SUPPORT RECTANGULAIRE, NIVEAU 2**
rectangular tray, level 2
 soporte rectangular, nivel 2
L 42 x P 30,8 x h 29,8 cm w 16,5 x d 12,1 x h 11,7 inch
3. **202906 - SUPPORT RECTANGULAIRE, NIVEAU 3**
rectangular tray, level 3
 soporte rectangular, nivel 3
L 40 x P 30,8 x h 48,8 cm w 15,7 x d 12,1 x h 19,2 inch
4. **202904 + 202905 - SUPPORTS RECTANGULAIRES NIVEAUX 1+2**
rectangular tray, levels 1+2
 soporte, nivel 1+2
L 44 x P 50 x h 29,8 cm w 17,3x d 20 x h 11,7 inch
5. **202905 + 202906 - SUPPORTS RECTANGULAIRES NIVEAUX 2+3**
rectangular tray, levels 2+3
 soporte, nivel 2+3
L 42 x P 50 x h 48,8 cm w 16,5 x d 20 x h 19,2 inch
6. **202904+202905+202906-SUPPORTS RECTANGULAIRES 1+2+3 NIVEAUX**
rectangular tray, 1+2+3 levels
 soporte, nivel 1+2+3
L 44 x P 68,2 x h 48,8 cm w 17,3 x d 26,9 x h 19,2 inch
7. **202910 - CADRE ACIER POUR SUPPORT RECTANGULAIRE**
steel frame for stand
 estructura de acero, soporte rectangular
L 55,5 x P 35 x h 4,5 cm w 21,9 x d 13,8 x h 1,8 inch
8. **202850 - PANIÈRE RECTANGULAIRE**
rectangular bread basket
 cesta bollería rectangular
54 x 34 x h 7 cm 21,3 x 13,4 x h 2,8 inch
9. **202902 - SUPPORT ROND BAS**
round stand, low level
 soporte redondo bajo
Ø 25 cm x h 13 cm - 9,8 x h 5,1 inch
10. **202903 - SUPPORT ROND HAUT**
round stand, high level
 soporte redondo alto
Ø 25 cm x h 26 cm - 9,8 x h 10,2 inch
11. **202851 - PANIÈRE RONDE**
round bread basket
 cesta bollería redonda
Ø 32 cm x h 8 cm - 12,6 x h 3,1 inch
12. **202852 - PANIÈRE INDIVIDUELLE**
individual bread basket
 cesta bollería individual
Ø 18 cm x h 6 cm - 7,1 x h 2,4 inch
13. **136524 - PLAT À TARTE PORCELAINE MODULO**
modulo porcelain pie dish
 plato porcelana modulo
Ø 32 cm - 12,6 inch
14. **142722 - BOL PORCELAINE MODULO**
modulo porcelain bowl
 bol porcelana modulo
Ø 28 cm - 11 inch
15. **202914 - ARDOISE RONDE**
round slate - pizarra redonda
Ø 32 cm - 12,6 inch
 épaisseur : 8 mm thickness : 0,3 inch espesor : 8 mm
16. **202854 - PLANCHE À PAIN AVEC RÉCUPÉRATEUR DE MIETTES ADAPTABLE AU SUPPORT FROID**
bread board with crumb tray can be used on a cold base (no cooling feature but for appearance purposes if required)
 panera bamboo
53 x 32,5 (GN1/1) cm - 20,9 x 12,8 (GN1/1) inch
17. **189343 - COUPEAU À PAIN OPTIMA POSITIONNABLE DANS LA PLANCHE**
Optima bread knife fits in a slot in the bread board
 Acier spécial coutellerie - special knife steel - cuchillo de pan optima
L 22 cm - 8,6 inch

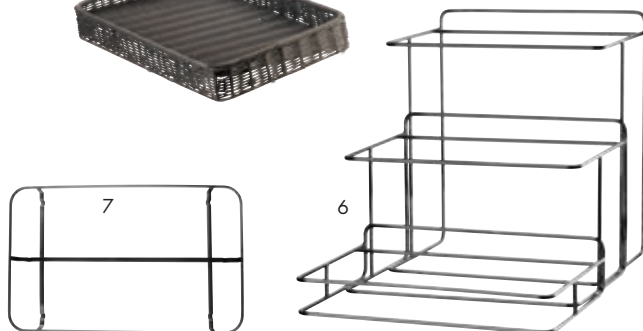
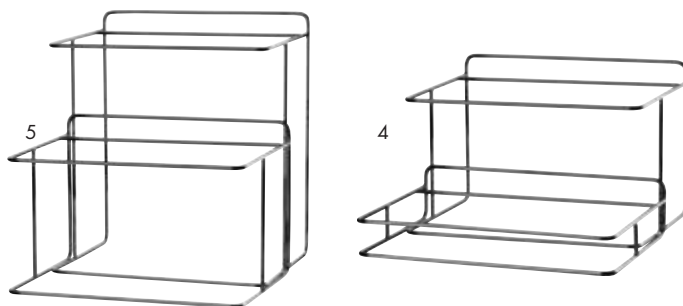
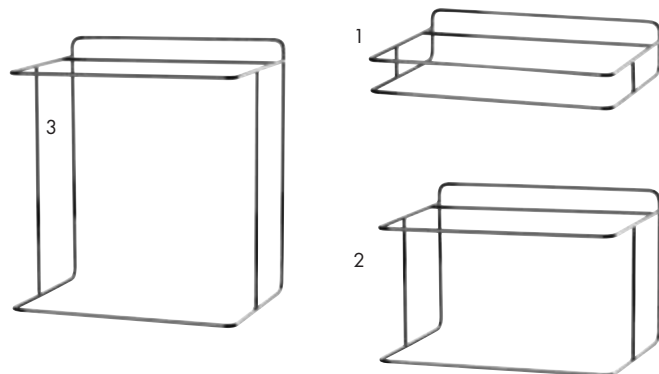

evento+

Les supports éleveurs sont parfaitement empilables pour le rangement
Stands can be stackable easily for storage

Soportes elevadores pueden ser apilables para un fácil almacenaje

Panière reversible pour une présentation droite ou inclinée.

reversible basket for a level or tilted display.

panera reversible para una presentacion derecha o inclinada.



evento
DOUCEUR



evento+

Etiquette porcelaine à aimanter sur le couvercle de l'urne ou sur le module réfrigéré. Peut se positionner aussi sur chevalet.

Magnetic porcelain label accessory for attachment to the cover of the urn, the refrigerated stand, or displayed on the table.

Imán de porcelana para pegar a la tapa de la urna al módulo refrigerado. También puede colocarse sobre un caballete.



1. 202633 - SUPPORT COUVERTS DE SERVICE BLANC

white serving cutlery display
soporte blanco para cubiertos de servicio
21 x 10 x 5 cm 8,3 x 3,9 x 2 inch



2. 203332 - SUPPORT COUVERTS DE SERVICE NOIR

black serving cutlery display
soporte negro para cubiertos de servicio
21 x 10 x 5 cm 8,3 x 3,9 x 2 inch



3. 202631 - PRÉSENTOIR DE TABLE EN PORCELAINE

porcelain table center piece
pieza de porcelana centro de mesa
15,5 x 7,5 cm 6,1 x 3 inch



4. 202632 - ETIQUETTE EN PORCELAINE ET ACIER (AVEC AIMANT)

porcelain and stainless table display (with magnet)
etiqueta en acero y porcelana
10 x 5 cm - 3,9 x 2 inch



5. 202626 - BOL EMPILABLE EVENTO

evento stackable bowl
bol evento apilablee
Ø 13,5 cm - 45 cl - 5,31 inch - 15 oz



6. 202854 - PLANCHE À PAIN AVEC RÉCUPÉRATEUR DE MIETTES ADAPTABLE AU SUPPORT FROID

bread board with crumb tray can be used on a cold base (no cooling feature but for appearance purposes if required)
panera bamboo
53 x 32,5 (GN1/1) cm - 20,9 x 12,8 (GN1/1) inch



7. 189343 - COUTEAU À PAIN OPTIMA POSITIONNABLE DANS LA PLANCHE

Optima bread knife fits in a slot in the bread board
Acier spécial coutellerie - *special knife steel* - cuchillo de pan optima
modulo porcelain pie dish
plato porcelana modulo
L 22 cm - 8,6 inch



8. 167261 - WOK

wok
wok
Ø 36 cm - 14,2 inch



evento
ACCESSOIRES
ACCESSORIES





Appelez votre logo ou un trait de jauge sur la paraison ou le pied de vos verres. Un logo sur la paraison peut également faire office de jauge. La personnalisation de vos verres avec un logo d'une ou plusieurs couleurs ou un trait de jauge à la contenance de votre choix est réalisée à partir de 120 pièces. **Chaque projet est unique et fait l'objet d'une étude personnalisée. Des frais forfaitaires de développements sont applicables à tout projet de personnalisation.**



Add your logo to the bulb or foot of your glasses to personalise your table or buffet to the very last detail. The logo on the bulb can also serve as a measurement line. Personalisation of your glasses with a logo in one or more colours or a measurement line to the capacity of your choice is carried out on a minimum of 120 pieces. **Every project is unique and undergoes personalised examination. Additional development fees apply to all personalisation projects.**

Los copas
Estampe su logo en la masa del vidrio o en el pie de sus copas. El logo en la masa del vidrio puede servir para medir el nivel de capacidad. La personalización de sus copas con un logo de uno o varios colores o de un indicador de nivel de su elección se realiza a partir de 120 piezas. **Cada proyecto es único y es objeto de un estudio personalizado. Se aplican gastos globales de desarrollo a cualquier proyecto de personalización.**

ALWAYS AT YOUR SERVICE

PERSONALISATION OF PORCELAIN

From simply applying your logo or edging in your colours, to more elaborate decoration on porcelain. 2 firing techniques are considered depending on your needs :

High-temperature firing at 1230° gives the decorations long-lasting resistance.

Low temperature firing allows a wider choice of colours to be obtained.

- Personalisation of your crockery with a logo or coloured edging carried out on a minimum of 250 pieces with the possibility of re-ordering a minimum of 100 pieces over the 3 years following the initial order

- Development of a specific decoration carried out on a minimum of 300 pieces with the possibility of re-ordering a minimum of 100 pieces over the 3 years following the initial order.

The porcelain labels that may be affixed magnetically to various Evento surfaces can be also personalised or hand-painted to suit your menu.



La excelencia del saber hacer de Degrenne, sutil mezcla de artesanía e industria, permite ofrecerle un servicio a medida para personalizar su mesa, su servicio de habitaciones o su bufet.

La personalización está disponible en todas las familias de productos : la vajilla, los cubiertos, la cristalería y la platería, para permitirle crear una oferta que refleje su estilo único y la identidad de su universo.

Gravado, marcado con láser de textos y logo, impresión de decoraciones, acabados especiales, plateado o dorado, creación de productos a medida.

PERSONALIZACIÓN EN PORCELANA

Desde la simple aplicación de su logo o de un borde con sus colores, a la de una decoración más elaborada en porcelana.

Dos técnicas de cocción previstas en función de sus expectativas:

La cocción a fuego fuerte, a 1230° para ofrecer una resistencia de larga duración de las decoraciones.

La cocción a fuego lento para obtener una gama de colores más amplia.

- Personalización de su vajilla con un logo o un borde de color realizado a partir de 250 piezas con posibilidad de renovar las existencias con un mínimo de 100 piezas en los 3 años siguientes al primer pedido.

- Desarrollo de una decoración específica realizada a partir de 300 piezas con posibilidad de renovar las existencias con un mínimo de 100 piezas en los 3 años siguientes al primer pedido.

Las etiquetas de porcelana previstas para imantarse a los diferentes soportes Evento pueden también personalizarse o pintarse a mano a imagen de su menú.

TOUJOURS À VOTRE SERVICE

DES SERVICES SUR-MESURE POUR LES PROFESSIONNELS DE LA RESTAURATION ET DE L'HÔTELLERIE

L'excellence du Savoir-Faire Degrenne, subtil mélange d'artisanat et d'industrie, permet de vous offrir un service sur-mesure pour **personnaliser votre table, votre room-service ou votre buffet.**

La personnalisation est disponible sur toutes nos familles de produits : **la vaisselle, les couverts, la verrerie et la platerie**, pour vous permettre de créer une offre qui reflète votre style unique et l'identité de votre univers.

Découvrez les techniques : gravure, marquage au laser de textes et de logos, impression de décors, finitions spéciales, argenture ou dorure



PERSONNALISATION SUR VAISSELLE

De la simple application de votre logo ou d'un filet à vos couleurs, à celle d'un décor plus élaboré sur porcelaine

En fonction de vos attentes 2 techniques aux choix vous sont proposées :

Personnalisation de votre vaisselle avec un logo ou un filet de couleur réalisée à partir de 250 pièces avec possibilité de faire un réassort de 100 pièces minimum dans les 3 années suivant la première commande.

Développement d'un décor spécifique réalisé à partir de 300 pièces avec possibilité de faire un réassort de 100 pièces minimum dans les 3 années suivant la première commande

Les étiquettes en porcelaine prévues pour être aimantées sur différents supports evento peuvent aussi être personnalisées ou peintes à la main à l'image de votre menu.



The excellence of Degrenne expertise, a subtle blend of craftsmanship and industry, allows us to offer you a tailor-made service for personalising your table, room service or buffet.

*Personalisation is available for all our product families: **crockery, cutlery, glassware and dishware**, allowing you to create a collection to reflect your unique style and identity.*

Engraving, laser engraving of texts and logos, printing of decorations, special finishing, silver- or gold-plating, creation of made-to-measure products.



LASER ENGRAVING ON CUTLERY

A process allowing highly precise markings to be made to personalise your cutlery with your logo or the text of your choice.

Laser engraving is offered for a minimum of 120 pieces.

CUSTOM STAMPING OF CUTLERY

A technique that offers high-quality relief marking.

Custom stamping is offered for a minimum of 120 pieces with the exception of knives with hollow handles.

SIEMPRE A SU SERVICIO

GRAVURE LASER

Un procédé qui permet un marquage de grande précision pour personnaliser vos couverts ou la platerie avec votre logo ou le texte de votre choix.

La gravure laser est proposée pour un minimum de 120 pièces.

MARQUAGE AU POINÇON

Une technique qui offre un marquage en relief de grande qualité

Le marquage au poinçon est proposé pour un minimum de 120 pièces à l'exception des couteaux manche orfèvre

GRAVADO LÁSER EN CUBIERTOS

Un procedimiento que permite un marcado de gran precisión para personalizar sus cubiertos con su logo o el texto de su elección.

Se propone el gravado láser para un mínimo de 120 piezas.

MARCADO CON PUNZÓN DE LOS CUBIERTOS

Una técnica que ofrece un marcado en relieve de gran calidad

Se propone el marcado con punzón para un mínimo de 120 piezas con la excepción de los cuchillos con mango de orfebrería.



CRÉATION DE PRODUITS SUR-MESURE

Parce que chaque détail compte pour offrir une expérience unique à vos clients, Degrenne réalise des produits sur-mesure.

Nos designers et notre service de recherche et développement s'appuient sur un savoir-faire construit au fil du temps pour développer des produits d'après vos dessins ou en étudiant pour vous le design qui donnera vie à vos envies...

Degrenne accompagne ses clients pour leur offrir le meilleur. Bénéficiez d'un conseil personnalisé et une étude de votre projet en contactant nos équipes commerciales.

CREATING TAILOR-MADE PRODUCTS

Because every detail counts when offering your clients a unique experience, Degrenne creates tailor-made products.

Our designers and our research and development department rely on expertise built up over time in order to develop products according to your designs

or create on your behalf the design that will bring your desires to life...

Degrenne works with its customers in order to offer them the very best. Enjoy personalised advice and an examination of your project by contacting our sales teams.

CREACIÓN DE PRODUCTOS A MEDIDA

Porque cada detalle cuenta para ofrecer una experiencia única a sus clientes, Degrenne realiza productos a medida.

Nuestros diseñadores y nuestro servicio de investigación y desarrollo se basan en un saber hacer construido a lo largo del tiempo para desarrollar productos según sus diseños y estudiando para usted el diseño que dará vida a sus deseos...

Degrenne acompaña a sus clientes para ofrecerles lo mejor. Beneficiéese de un asesoramiento personalizado y de un estudio de su proyecto poniéndose en contacto con nuestros equipos comerciales.

LE CONTRAT DE SERVICE RÉASSORT : UN SERVICE DE RÉASSORT GARANTI DANS LE TEMPS POUR LES COUVERTS DEGRENNE

Classique ou contemporain, aux lignes sobres ou plus élaborées, chaque modèle de couvert Degrenne est conçu pour durer dans le temps.

Degrenne s'engage dans le temps avec ses clients en offrant la possibilité d'effectuer un réassort pendant les 4 années qui suivent l'arrêt d'un modèle.

Les commandes réalisées dans le cadre du contrat de service réassort peuvent être passées une fois par an sur les couverts d'un modèle supprimé du catalogue à l'exception des pièces de service avec un tarif majoré de 10%.

THE RE-ORDERING SERVICE CONTRACT: A GUARANTEED RE-ORDERING SERVICE OVER TIME FOR DEGRENNE CUTLERY

Classic or contemporary, with sober or more elaborate lines, each Degrenne cutlery model has been designed to last.

Degrenne makes a long-term commitment to its customers by offering the possibility of re-ordering for 4 years after a model has been discontinued.

Orders carried out under the re-ordering service contract may be placed once a year for the cutlery of a model removed from the catalogue with the exception of service pieces with a 10% supplement.

EL CONTRATO DE SERVICIO DE RENOVACIÓN DE EXISTENCIAS: UN GARANTIZADO EN EL TIEMPO PARA LOS CUBIERTOS DEGRENNE

Clásico o contemporáneo, con líneas sobrias o más elaboradas, cada modelo de cubierto Degrenne está diseñado para durar en el tiempo.

Degrenne se compromete en el tiempo con sus clientes ofreciendo la posibilidad de efectuar una renovación de existencias durante los 4 años siguientes al descatalogamiento de un modelo.

TOUJOURS À VOTRE SERVICE

L'ARGENTURE DEGRENNE EST RÉALISÉE SUR DEMANDE DANS LA TRADITION DES GRANDS ORFÈVRES.

L'argenterie est proposée avec un minimum de commande de :

- 24 pièces pour les couverts de table et couverts de service pour l'argenterie de Classe I
- 144 pièces pour les couverts de table et 24 pièces pour les couverts de service pour l'argenterie de qualité hôtelière

Silver plating is offered with a minimum order quantity of:

- 24 pieces for table and service cutlery for Class I silver plating
- 144 pieces for table cutlery and 24 pieces for service cutlery for hotel - quality silver plating

El plateado se propone con un pedido mínimo de:

- 24 piezas para cubiertos de mesa y cubiertos de servicio para el plateado de Clase I
- 144 piezas para los cubiertos de mesa y 24 piezas para los cubiertos de servicio el plateado de calidad hotelera.

LA DORURE LA FINITION BROSSÉE

Nous offrons la possibilité de dorer à l'or fin certains couverts ou certaines parties des couverts pour donner un effet spectaculaire à vos tables.

We offer the possibility of adding fine gold plating to certain cutlery or certain parts of the cutlery to give a spectacular effect to your tables
Ofrecemos la posibilidad de dorar con oro fino algunos cubiertos o algunas partes de los cubiertos para dar un efecto espectacular a sus mesas

La finition brossée est obtenue par polissage avec une brosse spéciale.

Il est possible de satiner la lame du couteau ou de garder un effet miroir sur cette partie du couvert.

Cette finition est proposée sur un minimum de 24 pièces sur les modèles :

A brushed finish is obtained by polishing the cutlery with a special brush. It is possible to satin-brush the blade of the knife or retain a mirror effect on this part of the cutlery.

This finish is offered on a minimum of 24 pieces on the :

El acabado mate se obtiene mediante el pulido del cubierto con un cepillo especial. Es posible satinar la hoja del cuchillo o mantener un efecto espejo en esa parte del cubierto.

Esta acabado se propone para un mínimo de 24 piezas para los modelos :

Verlaine, Contour, Lutèce, Neuilly, Blois, Florencia, Marquise, Milady, Isatis, Ovation, Aquatic, Serenity, Confidence, Mikado, Norway, Aloa, Astrée, Sillages, Solstice, XY, Guest et Squadro.

ARGENTURE DE CLASSE I
33 microns avec poinçon de maître
CLASS I SILVER PLATING
33 microns, with hallmark
PLATEADO DE CLASE I
33 micras con punzón de maestro



ARGENTURE QUALITÉ HÔTELIÈRE
avec poinçon de maître
HOTEL-QUALITY SILVER PLATING
with hallmark
PLATEADO DE CALIDAD HOTELERA
con punzón de maestro



NOS PARTENAIRES
OUR PARTNERS
NUESTROS SOCIOS



www.lescuisiniersdelarepublique.com



www.meilleursouvriersdefrance.info



www.maitrescuisiniersdefrance.com



www.eurotoques.org



www.coupe-georges-baptiste.fr



www.toquesfrancaises.net



www.centreformation-alainducasse.com



www.tecomah.fr



www.ferrandi-paris.fr



institutpaulbocuse.com



aflyht.net



traiteurs-de-france.com



www.cdre-france.fr



www.anpcr.asso.fr



adeauville.com/siteclient/toquesnormandes



restaurateurs-alsace.fr



COMME EUX, FAITES NOUS CONFIANCE
TRUST US, LIKE THEY DO

ACCOR (SOFITEL, MGALLERY, PULLMAN, NOVOTEL, MERCURE, IBIS)

FOUR SEASONS

FRHI (FAIRMONT, RAFFLES, SWISSÔTEL)

MARRIOTT (JW MARRIOTT, RITZ CARLTON, MARRIOTT...)

CARSLON REZIDOR HOTEL GROUP (RADISSON, PARK INN)

IHG GROUP (INTERCONTINENTAL, HOLIDAY INN, INDIGO...)

HILTON WORLDWIDE (WALDORF ASTORIA, CONRAD, HILTON, DOUBLETREE...)

LOUVRE HOTELS (CAMPANILE, GOLDEN TULIP)

STARWOOD (WESTIN, W HOTELS, MERIDIEN, SHERATON, ST REGIS)

HYATT

BEACHCOMBER

CHEVAL BLANC

CHATEAUFORM'

CLUB MED

CORINTHIA

GROUPE LUCIEN BARRIERE

GROUPE MÈRE POULARD

DAN HOTEL

LANGHAM

LEELA

LE FUTUROSCOPE

LOTTE

MGM

OETKER COLLECTION

PENINSULA

RESIDENCES VERSACE

ROSEWOOD

ROTANA

WARWICK



Sélection Degrenne
Degrenne's selection
selección Degrenne



Garantie micro-ondes
microwave safe
garantía microondas



Garantie lave-vaisselle
dishwasher safe
garantía lavavajillas



Alimentaire
safe for food
apto para uso alimentario



Finition métal argenté - Argenture Classe 1 - 33 microns
silver plated finish - Class 1 silverplating - 33 microns
acabado plateado - tipo Clase 1 - 33 micras



Argenture qualité hôtelière
silver plated hotel quality
acabado hotel quality



Finition miroir
mirror finish
acabado brillo



Finition brossée
brushed finish
acabado cepillado



Forgé
forged finish
acabado forgé

18%

18-10

acier inoxydable
stainless steel
acero inoxidable



épaisseur
thickness
espesor



Porcelaine
porcelain
porcelana



Porcelaine de Limoges
Limoges porcelain
porcelana de Limoges



Peint à la main
hand painted
pintado a mano



Verre
glass
cristal



Cristalin HQ
HQ low lead crystal
cristalino alta calidad



Soufflé bouche
blown glass
vidrio soplado a boca



1000 cycles garantis minimum
1000 wash cycles guaranteed
1000 ciclos de lavado garantizados

SIEGE SOCIAL SERVICE CLIENTS
REGISTERED OFFICE SALES DEPARTMENT

FRANCE

tel : 33 (0) 2 31 66 44 15

OTHER COUNTRIES

tel : 33 (0) 2 31 66 44 92
infohotel@guydegrenne.fr

FILIALES USA
SUBSIDIARIES

Tables de France north America
390 George street suite 407
New Brunswick, NJ USA 08901

tel : 1 732 565 0820
fax : 1 732 565 0828

jfagan390@cs.com

DIRECTION GENERALE MARKETING COMMERCIAL
GENERAL MANAGEMENT MARKETING SALES

17 rue des Jonnières
91570 Bièvres

tel : 33 (0) 1 60 19 73 73
fax : 33 (0) 1 60 19 74 22

SHOW ROOMS
PARIS (VILLAGE ROYAL)
NEW YORK (41 MADISON)
VIRE (CALVADOS)
MADRID (ESPAGNE)

rue Guy Degrenne - BP 50056
14502 Vire cedex - France

www.degrenneparis.com